

**IBM ThinkPad 380XD/385XD  
User's Guide**



**IBM ThinkPad 380XD/385XD  
User's Guide**

IBM

**Note**

Before using this information and the product it supports, be sure to read the general information under "Safety Information" on page viii, "Using Your Computer Comfortably and Safely" on page 31, and "Notices" on page 189.

**First Edition (November 1997)**

**The following paragraph does not apply to the United Kingdom or any country where such provisions are inconsistent with local law:**

INTERNATIONAL BUSINESS MACHINES CORPORATION PROVIDES THIS PUBLICATION "AS IS" WITHOUT ANY WARRANTY OF ANY KIND, EITHER EXPRESS OR IMPLIED, INCLUDING, BUT NOT LIMITED TO, THE LIMITED WARRANTIES OF MERCHANTABILITY OR FITNESS FOR A PARTICULAR PURPOSE. Some states do not allow disclaimers of express or implied warranties in certain transactions; therefore, this statement may not apply to you.

This publication could include technical inaccuracies or typographical errors. Changes are periodically made to the information herein; these changes will be incorporated in new editions of the publication. IBM may make improvements or changes in the products or the programs described in this publication at any time.

Requests for technical information about IBM products should be made to your IBM Authorized Dealer or your IBM Marketing Representative.

**Copyright International Business Machines Corporation 1997. All rights reserved.** Note to US Government Users – Documentation related to restricted rights – Use, duplication, or disclosure is subject to restrictions set forth in GSA ADP Schedule Contract with IBM Corp.

***Thank You for Selecting  
an IBM ThinkPad 380XD or 385XD Computer***

We at IBM have developed this ThinkPad 380XD or 385XD  
computer to meet  
both your technical requirements and your high quality  
expectations.

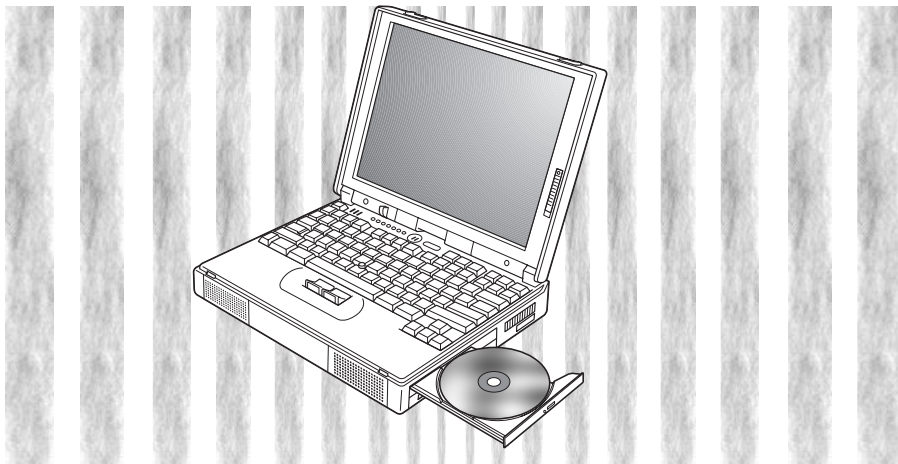

## Functional Highlights

### ***Welcome to the world of IBM ThinkPad computers!***

This powerful, all-in-one notebook computer includes a number of advanced technologies and user-friendly functions to make your computing experience more productive and pleasurable. Several of these functions are highlighted below. For additional details and functions, refer to the respective chapters in this book.

#### *High-speed processor*

The Intel Pentium 233 or 266 MHz (with MMX technology) processor provides high-speed data processing and advanced performance.

#### *Large-capacity hard disk drive*

The large-capacity hard disk drive provides for your demanding data storage needs. Since it is user-replaceable, it can be optionally upgraded, or you may choose to have a secondary hard disk drive.

#### *Large SVGA color LCD*

The 12.1-inch SVGA liquid crystal display (LCD) offers beautiful and clear pictures. Two models are provided, a TFT (thin-film transistor) model and a fast-response, high-brightness, and high-contrast HPA (high performance addressing) model.

#### *Advanced CD-ROM drive*

The advanced 10–24X data-reading-speed CD-ROM drive augments the computer's multimedia capabilities.

#### *Lithium-ion battery pack*

The large-capacity lithium-ion battery pack further extends the operating time of the computer.

#### *Audio features*

The computer has internal audio record and playback capabilities including 3D (three-dimensional) stereo sound from three speakers—two high quality stereo speakers and a subwoofer. The computer also supports DOS Sound Blaster Pro\*\* games.

### *PC Card support*

The computer provides two PC Card slots that accept a 16-bit PC Card, CardBus Card, and Zoomed Video Card.

### *Infrared communication*

The infrared communication technology allows wireless point-to-point communication at up to 4 megabits per second with any other ThinkPad computer or system equipped with an infrared port.

## About This Book

This book contains information that will help you operate the IBM ThinkPad 380XD or 385XD computer. Be sure to read the *ThinkPad Setup Guide* and Chapter 1 of this book before using the computer.

**Chapter 1. “Getting Familiar with Your Computer,”** acquaints you with the basic features of your computer.

**Chapter 2. “Operating Your Computer,”** provides information on installing options and using your computer’s high-technology features.

**Chapter 3. “Using Battery Power,”** describes how to operate your computer with the battery pack and provides power management information.

**Chapter 4. “Protecting Your Computer,”** provides information on using passwords, identifying yourself with the Personalization Editor, and using locks.

**Chapter 5. “Solving Computer Problems,”** describes what to do when you have a computer problem. The chapter includes a troubleshooting guide and information on how to recover lost or damaged software.

**Chapter 6. “Getting Service,”** describes various options of IBM’s support and service.

**Appendix A. “Features and Specifications,”** describes the features and specifications associated with your computer, including information on power cords.

**Appendix B. “Product Warranties and Notices,”** contains the warranty statements for your computer and notices for this book.

The **glossary** defines terms appearing in this book. The book concludes with an **index**.



### Icons Used in This Book

For procedures or information unique to the operating system installed in your computer:



Information for IBM Operating System/2 (OS/2) users.



Information for IBM DOS users.



Information for Microsoft Windows 3.11 users.



Information for Microsoft Windows NT users.



Information for Microsoft Windows 95 users.

# Safety Information



**DANGER**

**Electrical current from power, telephone, and communication cables is hazardous. To avoid shock hazard, connect and disconnect cables as shown below when installing, moving, or opening the covers of this product or attached devices. The 3-pin power cord must be used with a properly grounded outlet.**

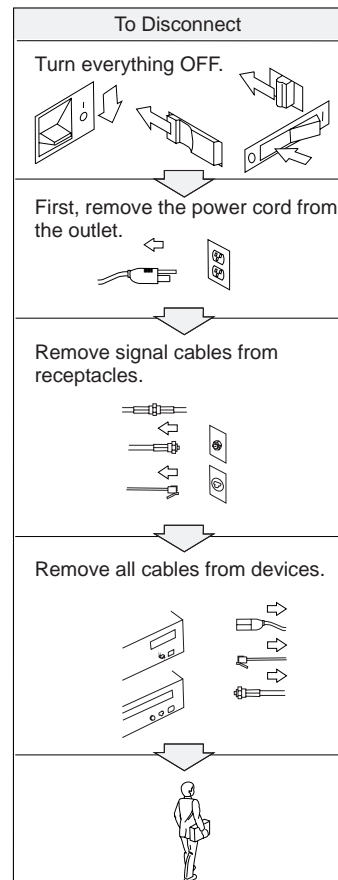
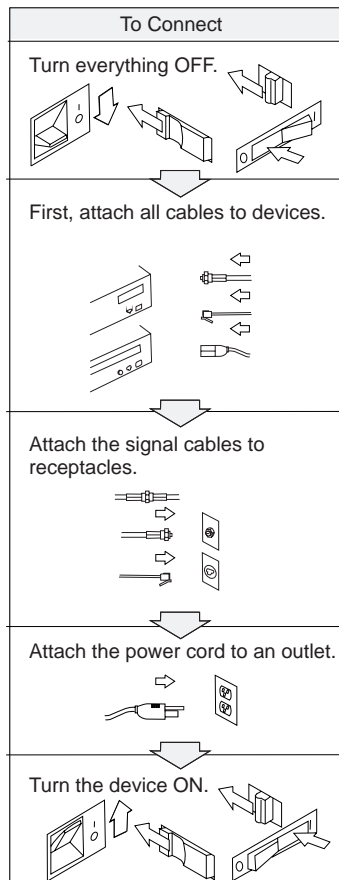

**Note:** In the U.K., by law:

The telephone line cable must be connected after the power cord.

The power cord must be disconnected after the telephone line cable.



**DANGER**

**Do not disassemble, incinerate, or short-circuit the rechargeable battery pack. Do not put it in trash that is disposed of in landfills. Dispose of it as required by local ordinances or regulations. In the United States, call IBM at 1-800-IBM-4333 for information on disposal.**

**CAUTION:**

The lithium battery can be replaced only by your dealer or an IBM service representative. It contains lithium and can explode if not properly used, handled, or disposed of. Do not: (1) throw or immerse into water, (2) heat to more than 100°C (212°F), or (3) repair or disassemble. Dispose of it as required by local ordinances or regulations.

**CAUTION:**

The fluorescent lamp in the liquid crystal display (LCD) contains mercury. Do not put it in trash that is disposed of in landfills. Dispose of it as required by local ordinances or regulations.

The LCD is made of glass, and rough handling or dropping the computer can cause the LCD to break. If the LCD breaks and the internal fluid gets into your eyes or on your hands, immediately wash the affected areas with water for at least 15 minutes; then get medical care if any symptoms are present after washing.

## Laser Compliance Statement

The CD-ROM drive in the IBM ThinkPad 380XD or 385XD is a laser product. The CD-ROM drive's classification label (shown below) is located on the top of the drive.

CLASS 1 LASER PRODUCT  
LASER KLASSE 1  
LUOKAN 1 LASERLAITE  
APPAREIL A LASER DE CLASSE 1  
KLASS 1 LASER APPARAT

The CD-ROM drive is certified in the U.S. to conform to the requirements of the Department of Health and Human Services 21 Code of Federal Regulations (DHHS 21 CFR) Subchapter J for Class I laser products.

In other countries, the drive is certified to conform to the requirements of EN60825.



### **CAUTION:**

**Do not open the CD-ROM drive; no user adjustments or serviceable parts are inside.**

**Use of controls, adjustments, or the performance of procedures other than those specified might result in hazardous radiation exposure.**

Class I (1) laser products are not considered to be hazardous. The CD-ROM drive has an internal, Class I (1), 0.5-milliwatt, aluminum gallium-arsenide laser that operates at a wavelength of 760 to 810 nanometers. The design of the laser system and the CD-ROM drive ensures that there is no exposure to laser radiation above a Class I (1) level during normal operation, user maintenance, or servicing conditions.





# Contents

---

Functional Highlights . . . . .	iv
About This Book . . . . .	vi
Safety Information . . . . .	viii
Laser Compliance Statement . . . . .	x
<b>Chapter 1. Getting Familiar with Your Computer . . . . .</b>	<b>1</b>
Locations . . . . .	2
System-Status Indicators . . . . .	8
ThinkPad Distinctive Functions . . . . .	10
Keyboard Functions . . . . .	10
CD-ROM Drive . . . . .	16
ThinkPad Utilities . . . . .	19
Online Book . . . . .	29
Backing Up Your System . . . . .	30
Recovery CD (Windows 95 Only) . . . . .	30
Diskette Factory . . . . .	30
Using Your Computer Comfortably and Safely . . . . .	31
Handling Your ThinkPad Computer . . . . .	31
Cleaning Your Computer . . . . .	33
Carrying Your Computer . . . . .	33
Extending Your Computer's Battery Life . . . . .	34
Ergonomics Information . . . . .	34
Ruggedized Mobile Computers . . . . .	36
For More Information . . . . .	36
<b>Chapter 2. Operating Your Computer . . . . .</b>	<b>39</b>
Increasing Memory Capacity . . . . .	40
Replacing the Hard Disk Drive . . . . .	44
Using an External Pointing Device . . . . .	48
Disabling the TrackPoint III . . . . .	51
Switching between the LCD and an External Monitor . . . . .	52
Attaching the Monitor . . . . .	52
Using SVGA Video Mode . . . . .	56
Using a PC Card . . . . .	58
Installing the PC Card . . . . .	59
Installing the PC Card Modem . . . . .	63
Using CardWorks . . . . .	66
Self-Check . . . . .	68
PC Card Information . . . . .	68
Stopping the PC Card . . . . .	72

Help	72
Using the Audio Features	73
Using the 3D Sound Retrieval System (SRS) Function	74
Using Infrared Communication	77
Using a Port Replicator	80
Attaching Your Computer to the Port Replicator	80
Detaching Your Computer from the Port Replicator	84
<b>Chapter 3. Using Battery Power</b>	<b>87</b>
Using the Battery Pack	88
Charging the Battery Pack	88
Monitoring the Battery Status	88
Saving Battery Power	93
Using the Power Management Modes	93
Customizing Power Management	99
Considerations When Using a Power Management Mode	102
Using Other Battery-Saving Methods	108
Replacing the Battery Pack	109
<b>Chapter 4. Protecting Your Computer</b>	<b>111</b>
Using Passwords	112
Entering a Password	112
Setting a Password	113
Changing or Removing a Password	117
Using the Personalization Editor	123
Using Locks	127
<b>Chapter 5. Solving Computer Problems</b>	<b>129</b>
Frequently Asked Questions	130
Hints, Tips, and Limitations	135
Troubleshooting Guide	136
Troubleshooting Charts	137
Error Codes or Screen Messages	138
No Error Codes or Screen Messages	142
Input Problems	143
Suspend or Hibernation Problems	144
LCD Problems	147
An Indicator Problem	148
Battery Problems	148
CD-ROM Drive Problems	149



Infrared Communication Problems . . . . .	150
A Universal Serial Bus (USB) Problem . . . . .	151
PC Card Problems . . . . .	151
A Printer Problem . . . . .	155
External Monitor Problems . . . . .	155
Port Replicator Problems . . . . .	157
Other Option Problems . . . . .	159
Software Problems . . . . .	161
Other Problems . . . . .	162
Testing Your Computer . . . . .	163
Recovering Lost or Damaged Software . . . . .	165
Using the Diskette Factory . . . . .	165
Using the Recovery CD (Windows 95 Only) . . . . .	167
<b>Chapter 6. Getting Service . . . . .</b>	<b>169</b>
Information on Your Computer . . . . .	171
Option List . . . . .	171
Identification Numbers . . . . .	171
Problem Recording Sheet . . . . .	172
HelpWare Customer Support and Service . . . . .	173
Help by Telephone . . . . .	173
ThinkPad EasyServ . . . . .	174
Getting Help around the World . . . . .	174
Fax Information . . . . .	175
Electronic Support Services . . . . .	175
Purchasing Additional Services . . . . .	177
Enhanced PC Support Line . . . . .	177
Client Support Line . . . . .	178
Network and Server Support Line . . . . .	178
Ordering Support Line Services . . . . .	178
Warranty and Repair Services . . . . .	179
Obtaining IBM Operating System Updates . . . . .	180
Getting Update Diskettes . . . . .	180
Ordering Publications . . . . .	180
<b>Appendix A. Features and Specifications . . . . .</b>	<b>181</b>
Features . . . . .	181
Specifications . . . . .	182
IBM Power Cords . . . . .	184

<b>Appendix B. Product Warranties and Notices</b> . . . . .	187
Notices . . . . .	189
Trademarks . . . . .	189
Electronic Emission Notice . . . . .	190
<b>Glossary</b> . . . . .	193
<b>Index</b> . . . . .	197

# Chapter 1. Getting Familiar with Your Computer

---

This chapter provides basic information about your computer.

Locations	2
System-Status Indicators	8
ThinkPad Distinctive Functions	10
Keyboard Functions	10
TrackPoint III	10
Fn Key Function	12
Numeric Keypad	15
CD-ROM Drive	16
ThinkPad Utilities	19
ThinkPad Configuration Program	19
Easy-Setup	25
Online Book	29
Backing Up Your System	30
Recovery CD (Windows 95 Only)	30
Diskette Factory	30
Using Your Computer Comfortably and Safely	31
Handling Your ThinkPad Computer	31
Cleaning Your Computer	33
Carrying Your Computer	33
Extending Your Computer's Battery Life	34
Ergonomics Information	34
Ruggedized Mobile Computers	36
For More Information	36



*Locations*

## Locations

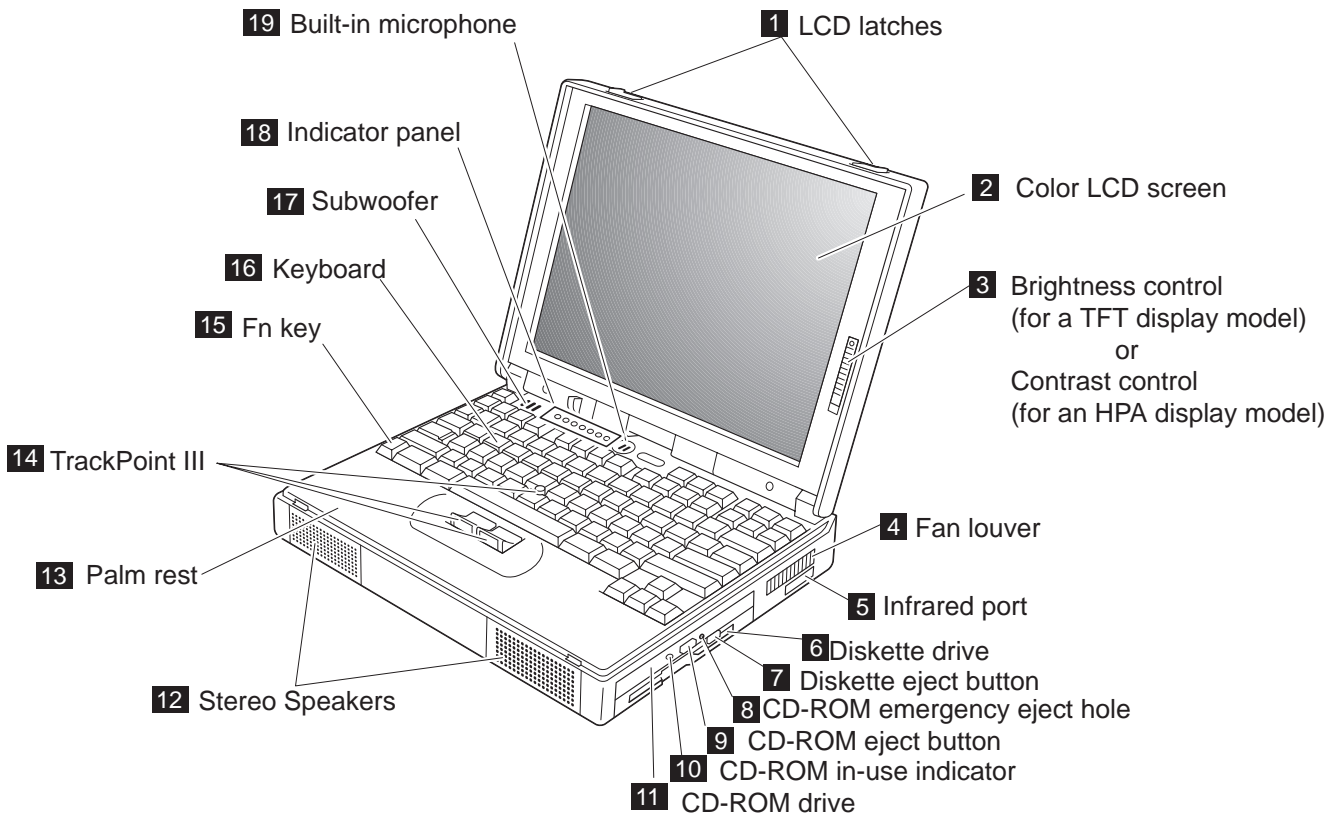
### Front View



## Locations

- 1 The **LCD latches** open the LCD when they are slid outward.
- 2 The **color LCD screen** displays computer output.
- 3  The **brightness control** (TFT model only) moves up or down to adjust the brightness of the display.  
 The **contrast control** (HPA model only) moves up or down to adjust the clarity of the picture.
- 4 The **fan louver** allows the inside of the computer to stay cool. **Do not place anything in front of the louver that might block air flow.**  
The cooling fan starts at power-on, and then stops and starts alternately depending on the temperature inside the computer.
- 5  The **infrared port** allows the computer to communicate with other devices that have infrared data-transfer capability.
- 6 The **diskette drive** reads data from or writes data to a diskette.
- 7 The **diskette-eject button** ejects the diskette from the diskette drive.
- 8 The **CD-ROM emergency eject hole** ejects the CD-ROM tray when it does not open with the CD-ROM eject button. Insert a pin into this hole to eject the tray.
- 9 The **CD-ROM eject button** ejects the CD-ROM tray from the CD-ROM drive. This button works only when the computer power is turned on.
- 1 The **CD-ROM drive in-use indicator** is on when data is read from a CD-ROM in the CD-ROM drive.
- 11 The **CD-ROM drive** reads data from a CD-ROM.
- 12 The **stereo speakers** along with the subwoofer <sup>17</sup> provide 3D (three-dimensional) stereo sound.
- 13 The **palm rest** is where you rest the palms of your hands when using the keyboard.
- 14 The **TrackPoint III** is a built-in pointing device that provides a function similar to that of a mouse.
- 15 The **Fn key** is used with the function keys to activate the **Fn** key functions.

## **Locations**





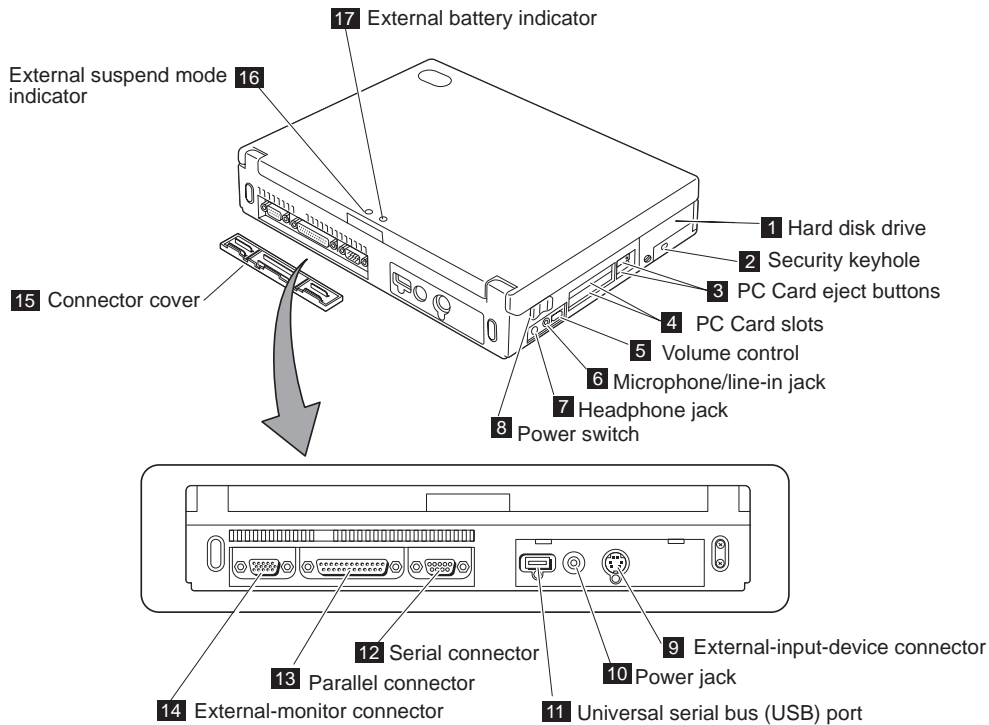

- 16 The **keyboard** is used to enter data into the computer. (To use the **numeric keypad** on the keyboard, see page 15.)
- 17 The **subwoofer** along with the stereo speakers 12 provide 3D (three-dimensional) stereo sound.
- 18 The **indicator panel** consists of the system-status indicators and their associated symbols.
- 19 The **built-in microphone** captures sound and voice when it is used with an application program capable of handling audio.

Rear View



- 1 The **hard disk drive** can be replaced with an optional one.
- 2  The **security keyhole** is used with a mechanical lock.
- 3 The **PC Card eject buttons** eject the PC Card from the PC Card slot.
- 4 The **PC Card slots** accept a PC Card, CardBus Card, and Zoomed Video Card.
- 5 The **volume control** adjusts the sound level for the built-in speaker.
- 6 The **microphone/line-in jack**, a  $\frac{1}{8}$ -inch (3.5-mm) diameter jack, is where you connect a stereo microphone or an external audio device.
- 7 The **headphone jack**, a  $\frac{1}{8}$ -inch (3.5-mm) diameter jack, is where you connect a stereo headphone or external speakers.
- 8 The **power switch** turns the computer on and off.

## Locations

- 9  The **external-input-device connector** is used to attach a mouse, external keyboard, or external numeric keypad to the computer.
- 1  The **power jack** is where the AC Adapter cable is connected.
- 11 The **universal serial bus (USB) port** is where the USB cable is connected.
- 12  The **serial connector** is where you connect a 9-pin serial-device cable.
- 13  The **parallel connector** is where you connect a parallel-printer signal cable.
- 14  The **external-monitor connector** is where you attach an external monitor.
- 15 The **connector cover** is removable.
- 16  The **external suspend mode indicator** shows the condition of suspend mode.
- 17  The **external battery indicator** shows the condition of the battery.



**Bottom View (with Battery Pack Installed)**

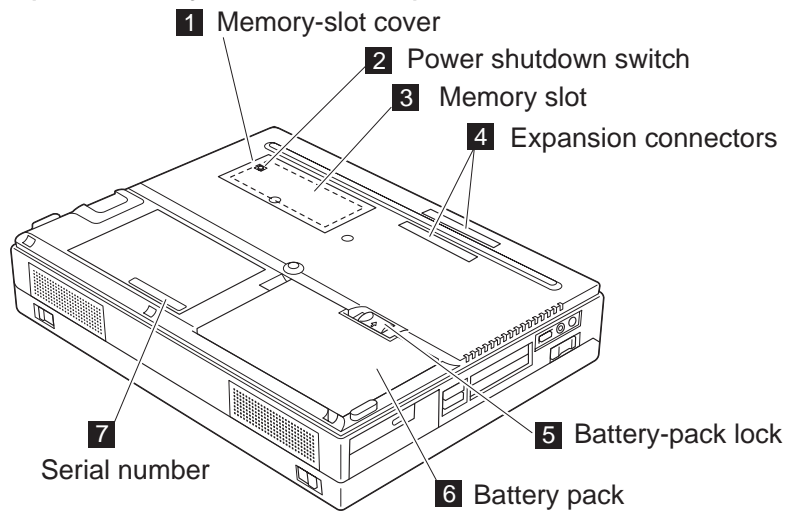

- |  |   |
|--|---|
| <p>1 The <b>memory-slot cover</b> covers the memory slot.</p> <p>2 The <b>power shutdown switch</b> is used to turn the computer off when an application locks up or the computer will not accept any input. Use the tip of a pen to press this switch.</p> <p>3 The <b>memory slot</b> accepts a dual inline memory module (DIMM) option.</p> | <p>4 The <b>expansion connectors</b> are where you attach a port replicator (available as an option).</p> <p>5 The <b>battery-pack lock</b> locks or releases the battery pack.</p> <p>6 The <b>battery pack</b> is a built-in power source for the computer.</p> <p>7 The <b>serial number (S/N)</b> identifies your computer.</p> |
|--|---|





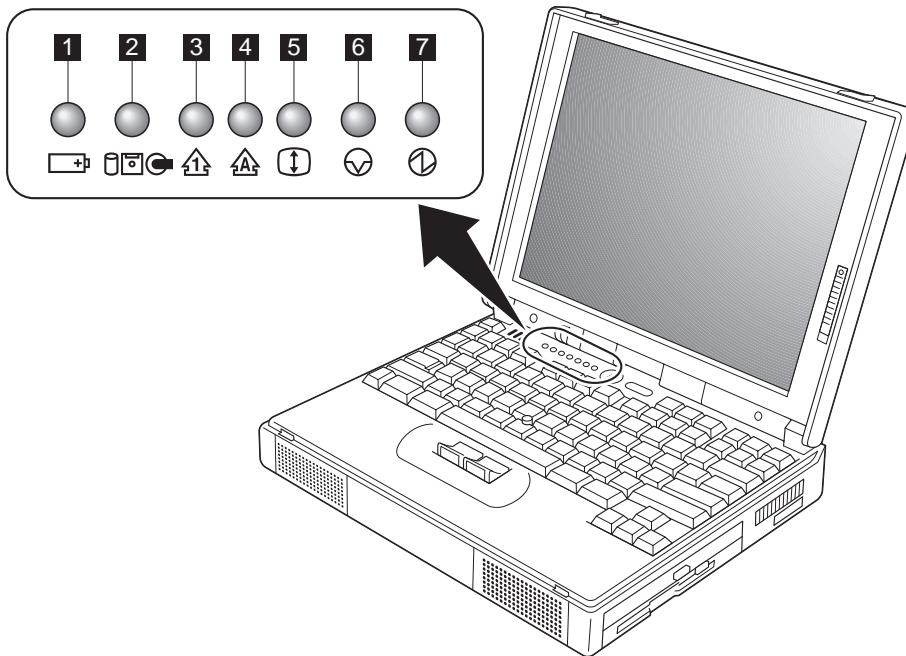

## System-Status Indicators

### System-Status Indicators

The system-status indicators on the computer show the current status of your computer by their on or off states and colors (green, yellow, or orange). Each indicator is identified with a symbol. The following shows the location and the meaning of each icon:



## System-Status Indicators

Symbol	Color	Meaning
1 Battery 	Green	Enough battery power remains for operation.
	Orange	The battery pack is being charged.
	Blinking orange	The battery pack needs charging. If the indicator starts blinking orange, the computer beeps three times.
2 Drive in use 	Orange	Data is being read from or written to the hard disk, the diskette drive, or the CD-ROM drive. <i>Do not enter suspend mode or turn off the computer when this indicator is on.</i>
3 Numeric lock 	Green	The numeric keypad on the keyboard is enabled. You enable or disable the keypad by pressing and holding the <b>Shift</b> key, and pressing the <b>NumLk</b> key. For details, see “Numeric Keypad” on page 15.
4 Caps lock 	Green	Caps Lock mode is enabled. All alphabetic characters (A–Z) are entered in capital letters without using the <b>Shift</b> key. You enable or disable Caps Lock mode by pressing the <b>Caps Lock</b> key.
5 Scroll lock 	Green	Scroll Lock mode is enabled. The <b>Arrow</b> keys can be used as screen-scroll function keys. The cursor cannot be moved with the <b>Arrow</b> keys. <i>Not all application programs support this function.</i> You enable or disable Scroll Lock mode by pressing the <b>ScrLk</b> key.
6 Suspend mode 	Green	The computer is in suspend mode. (See page 93 for details.)
	Blinking green	The computer is entering suspend mode or hibernation mode, or is resuming normal operation.
7 Power on 	Green	The computer is operational. This indicator is on when the computer is on and not in suspend mode.

## ThinkPad Distinctive Functions

This section describes the following distinctive functions of your computer:

Keyboard

CD-ROM drive

ThinkPad utilities (ThinkPad Configuration program and Easy-Setup)

Online book

### Keyboard Functions

Your ThinkPad computer's keyboard has the following functions:

TrackPoint III

**Fn** key function

Numeric keypad

#### *TrackPoint III*

The keyboard contains a unique cursor-pointing device called the *TrackPoint III*. Pointing, selecting, and dragging all become part of a single process you can perform without moving your fingers from their typing position.

**Note:**

No other software is required for the TrackPoint III; it works with the PS/2 mouse driver.

The TrackPoint III consists of a **stick** on the keyboard and a pair of **click buttons** in front of the keyboard. Movement of the pointer on the screen is controlled by the amount of pressure you apply to the nonslip cap on the stick in any direction parallel to the keyboard; the stick itself does *not* move. The speed at which the pointer moves corresponds to the amount of pressure you apply to the stick. The function of the click buttons corresponds to the left and right mouse buttons on a traditional mouse, and depends on the software you are using.

## ThinkPad Distinctive Functions

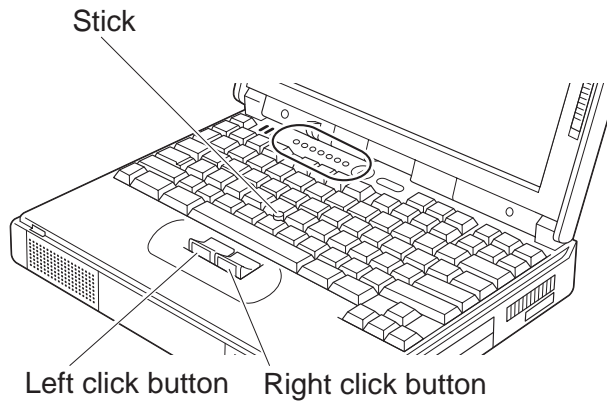

If you are not familiar with using the TrackPoint III, these instructions will help you get started:

- 1** Place your hands in the typing position and press gently on the stick with either index finger in the direction you want the pointer to move.

Pressing the stick away from you moves the pointer up the screen; pressing it toward you moves the pointer down the screen. You can also move the pointer side to side by pressing sideways.

**Note:**

The pointer might drift. This is not a defect. Do not use the TrackPoint III until the pointer stops moving.

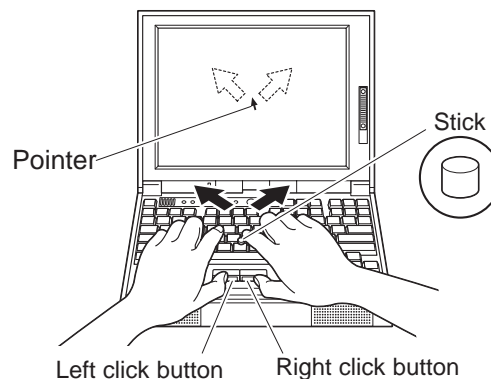

## ThinkPad Distinctive Functions

- 2 Press the click buttons with either thumb to select and drag as required by your software, as with any other pointing device.

### Changing the Cap

The cap 1 on the end of the TrackPoint III is removable. You can replace it with one of the spares shipped with your computer.

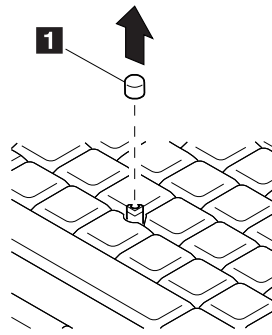

### F<sup>n</sup> Key Function

The **F<sup>n</sup>** key function allows you to change operational features instantly. When you use the following functions, press and hold the **F<sup>n</sup>** key 1 ; then press the appropriate function key 2 (**F1** to **F12**).

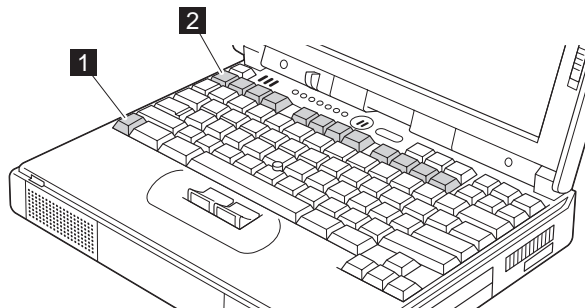









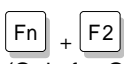

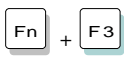
## ThinkPad Distinctive Functions

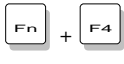
### The Fn Key Lock Function

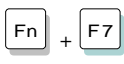
You can set up your computer so that you need to press **Fn** only once to get the same effect as when you press and hold **Fn**. With this setup, after you press a function key in the top row, **Fn** returns to its normal state. To set up the **Fn** key this way, select the **Accessibility** () button in the ThinkPad Configuration program window (refer to “ThinkPad Configuration Program” on page 19), or type `PS2 FNS E` at the command prompt.

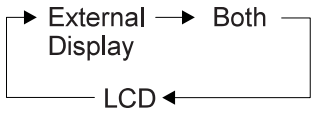
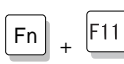
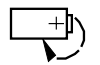
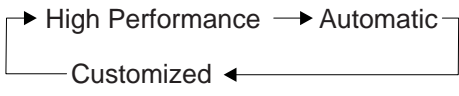
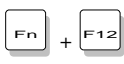
Function keys not shown in the following table have no function.

Key Combination	Feature	Meaning
 (Only for OS/2 or Windows users)	Fuel-Gauge display on or off 	The Fuel-Gauge program must be activated before you can use this key combination (refer to “Using the Fuel-Gauge Program” on page 92).  If you press this key combination, the window for the battery power status appears or disappears. You can set parameters for power status in the window.
	Standby mode 	The computer enters standby mode. For more information about this mode, see “Using the Power Management Modes” on page 93.
	Suspend mode 	The computer enters suspend mode. For more information about this mode, see “Using the Power Management Modes” on page 93.
	LCD or external monitor switching 	Computer output is displayed in the following order when an external monitor is attached. 
	Power mode switching 	During battery-power operation, the power mode changes as follows: 
	Hibernation mode 	The computer enters hibernation mode. See “Using the Power Management Modes” on page 93 for more information.

## ***ThinkPad Distinctive Functions***

**Note:** When the computer is in suspend mode and you press the **Fn** key independently without any function key, the computer returns to normal operation.



## ThinkPad Distinctive Functions

### Numeric Keypad

The keyboard has some keys that, when enabled, work as if they were a 10-key numeric keypad. (The numeric keypad on the keyboard is not active when the external keyboard or the external numeric keypad is attached to the computer.)

To enable or disable the numeric keypad, press and hold **Shift** and then press **NumLk**.

**Note:**

The functions of the numeric keypad are printed on the front of the keys.

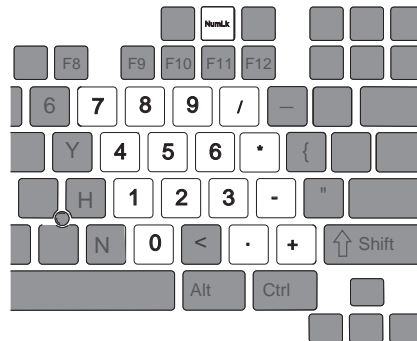

When the numeric keypad is enabled, press and hold **Shift** to temporarily use the cursor- and screen-control keys.

**Note:**

The functions of the cursor- and screen-control keys are not printed on the keys.

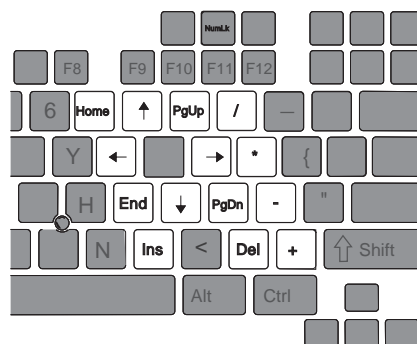

## CD-ROM Drive

ThinkPad 380XD or 385XD computer comes with a built-in CD-ROM drive, so you can use compact discs (CDs).

The following CDs are supported by the computer:

- Music CDs
- Photo CDs
- CD-ROM or CD-ROM XA
- Video CDs

To use the CD-ROM drive, do the following:

- 1** Turn on the computer.
- 2** Push the CD-ROM eject button on the side of the computer; then pull out the CD-ROM tray.
- 3** Fit your CD on the center pivot. Firmly press the CD down until you hear it click into place.

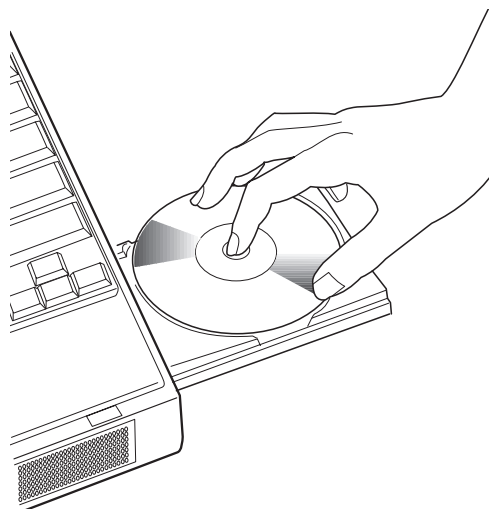

- 4** Push the tray into the computer until it fully closes.

The way you access the data on the CD depends on what type of CD it is.

## *ThinkPad Distinctive Functions*

To remove the CD, do the following:

- 1** Finish the application program that uses the CD.
- 2** Push the CD-ROM eject button; then pull out the CD-ROM tray.
- 3** Lift the CD by its edge while pressing the pivot.

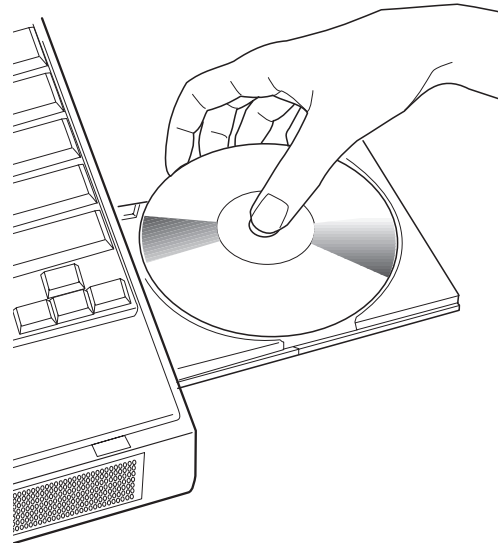

- 4** Push the tray into the computer until it fully closes.

## ***ThinkPad Distinctive Functions***

### **Handling CDs**

CDs are high-density media that must be handled with care and kept clean to ensure that data remains readable. Keep in mind the following to maintain reliability:

Hold the CD by the edges. Do not touch the surface of the CD.

To remove dust or fingerprints, wipe the CD from the center to the outside of the disc. Wiping the CD in a circular direction can cause loss of data.

Do not write on the surface.

Do not store or place the CD in direct sunlight.

Do not use benzene, thinners, or other cleaners to clean the CD. Use a CD-ROM cleaner kit.

Do not flex or bend the CD.

## ThinkPad Utilities

Your ThinkPad computer has the following utility programs for easy configuration:

ThinkPad Configuration program  
Easy-Setup

This section summarizes these utilities.

### *ThinkPad Configuration Program*

The ThinkPad Configuration program allows you to set up and customize the computer's built-in devices to your needs. For example, you can enable or disable a port, switch between your computer's LCD and an external monitor, and set the power management mode.

This section describes how to start the ThinkPad Configuration program.



#### **For Windows 95:**

To start the **ThinkPad Configuration** program for Windows 95:

- 1** Click on **Start**.
- 2** Move the cursor on **Programs, ThinkPad**; then click on **ThinkPad Configuration**.

The following window appears:

## ThinkPad Distinctive Functions

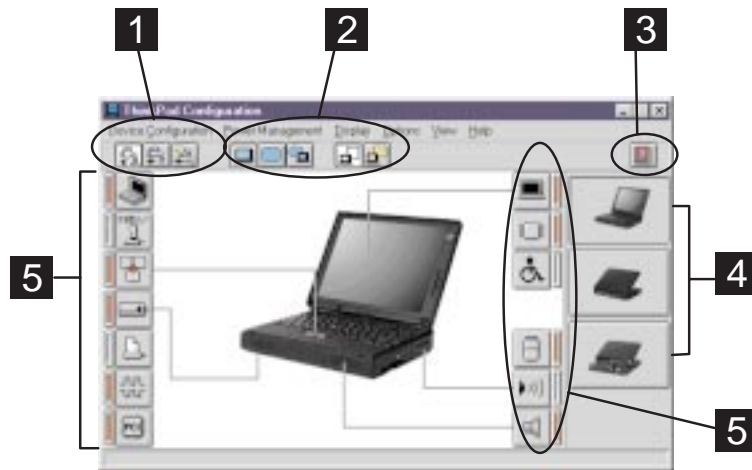

- 1 The **Power Mode** buttons  
Click on one of these buttons to set the power mode to high performance mode, automatic mode, or customized mode.
- 2 The **Display Device** buttons  
Click on one of these buttons to set the display output type to the LCD, external monitor, or both. When making a presentation, you can click on the screen-blanking button to disable any system timers, such as the LCD turn-off timer or the power management mode timers.
- 3 The **Help** button displays online help.
- 4 The **View Angle** buttons  
Click on the front view or rear view buttons to display the hardware feature locations.
- 5 The **Device** buttons  
Click on the button of your choice from the window.  
If the device is enabled, the red indicator next to the button is lit. Otherwise, it stays off.

## ThinkPad Distinctive Functions



### For Windows NT:

To start the **ThinkPad Configuration** program for Windows NT:

- 1 Click on **Start**.
- 2 Move the cursor on **Programs, ThinkPad**; then click on **ThinkPad Configuration**.



### For Windows 3.11:

Double-click on the **ThinkPad Configuration** icon.



### For OS/2:

To start the **ThinkPad Configuration** program for OS/2:

- 1 Double-click on the **ThinkPad Configuration** folder.
- 2 Double-click on **ThinkPad Configuration**.

The following window appears:

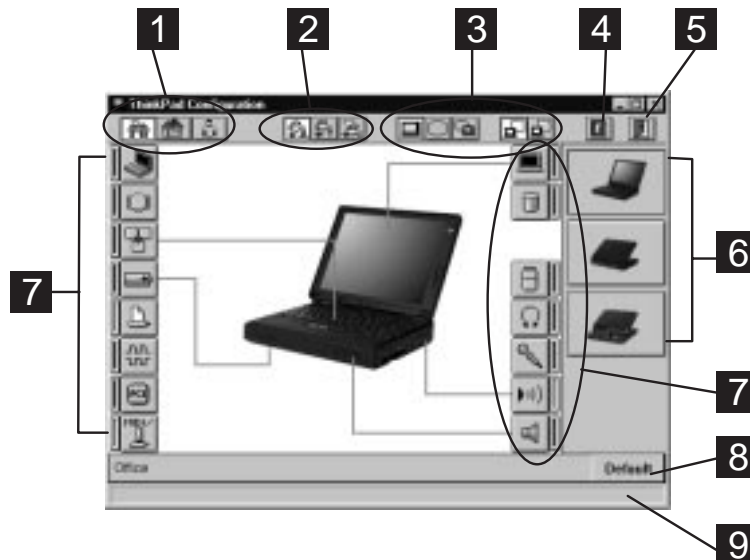

## **ThinkPad Distinctive Functions**

- 1 The **One-Touch Setup** buttons  
Click on one of these buttons to set the system configuration.
- 2 The **Power Mode** buttons  
Click on one of these buttons to set the power mode to high performance mode, automatic mode, or customized mode.
- 3 The **Display Device** buttons  
Click on one of these buttons to set the display output type to the LCD, external monitor, or both. When making a presentation, you can click on the screen-blanking button to disable any system timers, such as the LCD turn-off timer or the power management mode timers.
- 4 The **Help** button displays online help.
- 5 The **Exit** button  
Click on this button to save the changes made and to exit the ThinkPad Configuration window.
- 6 The **View Angle** buttons  
Click on the front view or rear view buttons to display the hardware feature locations.
- 7 The **Device** buttons  
Click on the button of your choice from the window; then set the options for that device from the window that appears.  
  
If the device is enabled, the red indicator next to the button is lit. Otherwise, it stays off.
- 8 The **Default** button  
Click on this button to set the default values for each option and to cancel the changes you just made.
- 9 The **Status** bar  
The device name and its status appears in the status bar when you place the cursor on a device button.

Only the top portion of the window is displayed when you click on the minimize button in the top-right corner.



## ThinkPad Distinctive Functions



### For DOS:

You can use the ThinkPad Configuration program from the DOS prompt. To start the program, do the following:

**1** Click on **Start**; then the **DOS Prompt** icon.

The DOS prompt window appears.

**2** Type **PS2 ?** at the DOS prompt.

The “ThinkPad Configuration” online help window appears:

```
C:\>PS2 ?

(C) Copyright IBM Corp. 1993,1997. All rights reserved.
US Government Users Restricted Rights - Use, duplication
or disclosure restricted by GSA ADP Schedule Contract
with IBM Corp.

Command Syntax: PS2 [Parameter1] [Parameter2] [Parameter3]

Following are available [Parameter1].
For the complete command syntax, type 'PS2 ?
[Parameter]'.

1.Power Management related
```

## ThinkPad Distinctive Functions

- 3 Select an item from the menu and follow the instructions on the screen to set the features.

You can also create a batch file like the one shown to match your operating environment. The following sample batch file sets a longer battery operating time.

```
@Echo Off

Rem SAMPLE:Set the parameters to provide maximum power utilization.

Rem =====

PS2 PMode Custom DC           > Nul
PS2 LCd 3                     > Nul
PS2 DISK 3                    > Nul
PS2 POver 5                   > Nul
PS2 SPeed Fixed Slow          > Nul
PS2 IR Disable                > Nul
PS2 SErIAL OFF                > Nul
```

## ThinkPad Distinctive Functions

### Easy-Setup

Your computer provides a user-friendly built-in system setup program called *Easy-Setup*. The program allows you to set the date and time, password, the startup sequence of the drives, and shows hardware configurations. The program also enables you to check for hardware errors by running a diagnostic test. You should run this program before you start using your computer. Follow these steps to start the program:

- 1** Turn off the computer, and remove any diskette from the diskette drive.
- 2** Press and hold **F1**; then turn on the computer. Hold **F1** until the “Easy-Setup” menu appears:

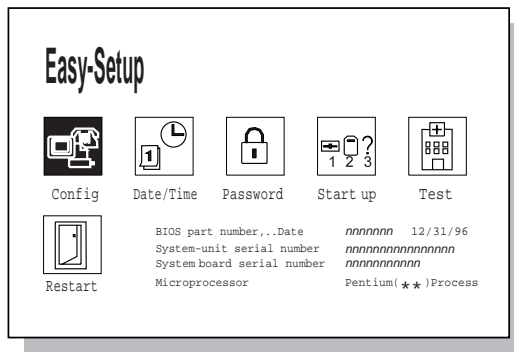

- 3** Move to an icon you want to change, using the arrow keys or the TrackPoint III, and click on the icon.  
A submenu is displayed.
- 4** Change the items you wish to change.
- 5** Click on **Exit** to exit to the submenu.
- 6** Click on **Restart** to exit to the “Easy-Setup” menu.  
Your computer restarts.

## ThinkPad Distinctive Functions

### Easy-Setup Submenus

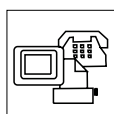

Config

Pressing the **Config** button displays the following “Config” submenu. It shows information about the installed memory and system board.

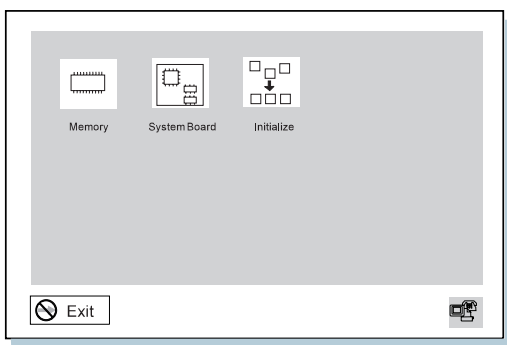

The **Memory** button shows the amount of memory installed and available.



The **System Board** button provides information on the system board installed.



**Initialize** sets all device settings to the default values.

## ThinkPad Distinctive Functions

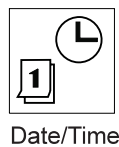

Date/Time

Pressing the **Date/Time** button displays the following “Date and Time” submenu. It is used to set the current date and time.

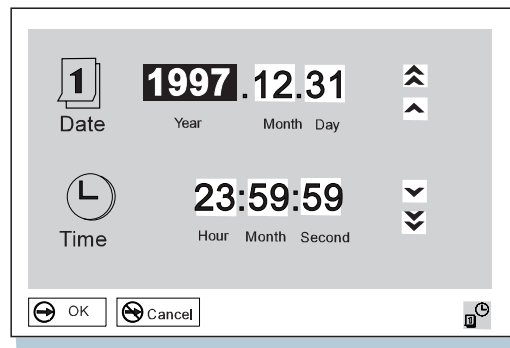

To change the date and time, do the following:

- 1** Move the cursor to any field (Year, Month, Day, Hour, Minute, or Second) and place the pointer on any of the arrow icons (⬆, ▲, ▼, or ⬇) to adjust the date and time.

Clicking on the double-arrow icon scrolls the numbers faster.

- 2** Click on **OK** to save the changes or on **Cancel** to cancel them.



Password

Pressing the **Password** button displays the “Password” submenu. It is used to set the power-on password, hard disk password, and supervisor password. Go to “Using Passwords” on page 112.

**Note:** An open lock icon shows that a password has not yet been set.

## ThinkPad Distinctive Functions

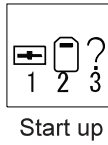

Pressing the **Start up** button displays the “Start up” submenu. It is used to change the startup sequence of the drive in your computer. For example, if you have different operating systems on different replaceable hard disk drives or PC Cards, you can have the system boot up from one of these devices.

### Attention

You must be extremely careful not to specify a wrong device during a copy, save, or a format operation after you change your startup sequence. If you specify a wrong device, your data and programs might be erased or overwritten.

To change the startup sequence, do the following:

- 1** Reset the current startup sequence by moving the cursor to the **Reset** icon; and click on it.

The sequence is reset, and all available device icons appear on the screen.

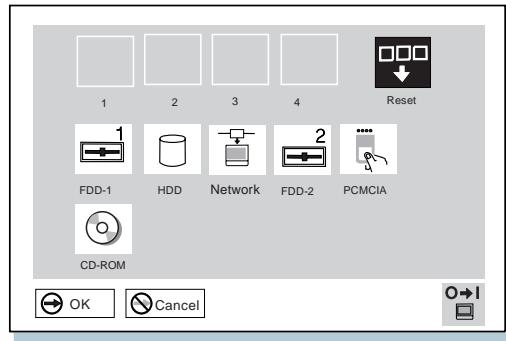

- 2** Select the first device you want for the startup sequence; then click on it.

Repeat this step to set the other devices for the startup sequence. You can set up to four devices.

- 3** Click on **OK** or press **Enter** to save the changes.

## ThinkPad Distinctive Functions

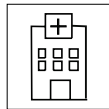

Test

Pressing the **Test** button displays the “Test” submenu. It is used to run diagnostic tests on your computer to check for hardware errors. Go to “Testing Your Computer” on page 163.

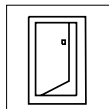

Restart

Pressing the **Restart** button ends the Easy-Setup program and restarts the computer.

### Changing the Screen Color

You can change the color of the “Easy-Setup” menu by pressing the **Ctrl+PgUp** keys or by pressing the **Ctrl+PgDn** keys.

To return to the original color, press the **Ctrl+Home** keys.

## Online Book

Your ThinkPad computer has an online book containing the following advanced information:

- Using your computer in foreign countries
- Using a PC Card
- Resolving system resource conflicts
- Installing software
- Controlling and managing systems over a network
- Solving computer problems

To start the online book, click on **Start**, move the cursor to **Programs** and **ThinkPad 380**, and then click on **ThinkPad 380 User's Guide**.

The online book appears. Go to the section you want, and make a printout if necessary.

## Backing Up Your System

Your computer comes with the necessary software already installed for you to use the computer right out of the box. If you want to restore your system to what it was at the time of purchase, and if you are using Windows 95, use the **Recovery CD**.

It is important to back up your software. For example, your software might become erased or corrupted, or you might want to install a new operating system in your computer. To back up your software, use the **Diskette Factory** program.

### Recovery CD (Windows 95 Only)

If you accidentally erase your hard disk, you can use the Recovery CD to restore the contents of the preloaded hard disk to what it was at the time of purchase. Refer to "Using the Recovery CD (Windows 95 Only)" on page 167.

### Diskette Factory

With the Diskette Factory program, you can create the utility and device driver diskettes for Windows 95, Windows NT, Windows 3.11, DOS, or OS/2. Refer to "Using the Diskette Factory" on page 165.



## Using Your Computer Comfortably and Safely

By using common sense and by following the handling tips in this section, you will get the most use and enjoyment out of your ThinkPad computer for a long time to come.

### Handling Your ThinkPad Computer

Notebook computers are precision machines that require a bit of careful handling. Though the IBM ThinkPad computer is designed and tested to be a durable notebook computer that functions reliably in normal work environments, you need to use some common sense in handling it.

#### **ThinkPad Don'ts:**

Do not subject your computer to physical punishment, such as dropping or bumping.

Do not place heavy objects on your computer.

Do not spill or allow liquids into your computer.

Do not use your computer in or near water (to avoid the danger of electrical shock).

Do not pack your computer in a tightly packed suitcase or bag. The compression might cause internal damage.

Do not disassemble your computer. Only an authorized IBM ThinkPad repairer should disassemble and repair your computer.

Do not scratch, twist, hit, or push the surface of your computer display.

Do not place any objects between the display and keyboard or under the keyboard.

Do not pick up or hold your computer by the display. When picking up your open computer, hold it by the bottom (keyboard) half.

Do not modify or tape the latches to keep the display open or closed.

Do not turn your computer over while the AC Adapter is plugged in. This could break the adapter plug.

## *Using Your Computer Comfortably and Safely*

Do not use or store your computer where the temperature is below 5° C or above 35° C (41° F and 95° F).

Do not place your computer closer than 13 cm (5 in.) from any electrical appliance that generates a strong magnetic field, such as a motor, a magnet, a TV, a refrigerator, or large audio speakers.

Do not hard-mount your computer in a vehicle or anywhere that it is subject to strong vibration. See "Ruggedized Mobile Computers" on page 36 for information on a more appropriate model for demanding applications.

Do not crush, drop, or physically punish the removable hard disk drive when it is outside of your computer.

Do not insert a diskette at an angle. Not inserting the diskette straight into the drive can damage the drive.

Do not place more than one label on a diskette. Multiple or loose labels can detach or tear and then lodge in the drive.

Do not touch the lens on the CD-ROM tray. You should hold the compact disc by the edges and not touch its surface.

Do not connect a PBX (private branch exchange) or other digital telephone extension line. **Your computer can use only a public-switched telephone network (PSTN).** Use of a phone line other than PSTN can damage your modem. If you are not sure which kind of phone line you are using, contact your telephone company. Many hotels or office buildings use digital telephone extension lines, so check before connecting the telephone cable in such places.

Do not leave the base of your computer in contact with your lap or any part of your body for an extended period when the computer is functioning or when the battery is charging. Your computer dissipates some heat during normal operation. This heat is a function of the level of system activity and battery charge level.

### **ThinkPad Do's:**

Store your removable hard disk drive in the appropriate container or packaging when not in use.

## ***Using Your Computer Comfortably and Safely***

When installing your hard disk drive, apply pressure only where indicated on the device.

Treat your computer like a precision piece of electronic machinery.

Retain and store packing materials safely out of reach of children to prevent the risk of suffocation from plastic bags.

Register your ThinkPad products with IBM (refer to the *Setup Guide*). This can help authorities return your computer to you if it is lost or stolen. Registering your computer also enables IBM to notify you about possible upgrades.

Check the IBM Web pages at **[www.us.pc.ibm.com](http://www.us.pc.ibm.com)** periodically to get current information about your computer.

## **Cleaning Your Computer**

You should occasionally clean your computer as follows:

Use a soft cloth moistened with nonalkaline detergent to wipe the exterior of the computer.

Don't spray cleaner directly on the display or keyboard.

Gently wipe the LCD with a dry, soft cloth.

## **Carrying Your Computer**

When carrying your computer, follow these instructions to prevent possible damage to your computer and data:

1. Remove any media from the CD-ROM drive or diskette drive.
2. Turn off all attached devices.
3. Turn off the computer and close the LCD.
4. Unplug all external cables and cords connected to your computer.
5. Make sure all computer doors and covers are closed.
6. Use a quality carrying case that provides adequate cushion and protection.

## **Extending Your Computer's Battery Life**

The amount of battery power consumed by your computer depends on such conditions as the usage frequency, the operating temperature, and the period of time in storage (if unused). The following tips can help you to extend the life of your battery:

Whenever possible, use the ThinkPad battery power-saving modes (See "Saving Battery Power" on page 93):

- **standby:** The LCD and the hard disk drive are turned off.
- **suspend:** All tasks are stopped and stored in memory to save power.
- **hibernation:** All tasks are stopped. The memory data and the current status of the computer are stored in the hard disk drive; then the power is turned off.

Decrease the LCD brightness.

Use Advanced Power Management (APM). Each operating system comes with its own APM.

Remove a PC Card if it is not in use.

Remove the battery pack and keep it in a cool place if you will not be using the computer for a long period.

## **Ergonomics Information**

You should read the following important information before using your portable ThinkPad notebook computer in your "virtual office."

Working in the virtual office may mean adapting to frequent changes in your environment. Following some simple "rules of the road" will make things easier and bring you the maximum benefits of your ThinkPad computer. Keeping in mind such basics as good lighting and proper seating, for example, can go a long way in helping you enhance your performance and achieve greater comfort wherever you are.

### ***What if I am traveling?***

It may not be possible to observe the best ergonomic practices when you are using the ThinkPad computer while on the move or in a "casual" setting. Regardless of the setting, try to observe as many of the tips for proper usage as possible. Sitting properly and using

## Using Your Computer Comfortably and Safely

adequate lighting, for example, will help you maintain desirable comfort and performance levels.

### Questions about vision?

IBM's visual display screens are designed to meet the highest standards and to provide you with clear, crisp images and large, bright displays that are easy to see, yet easy on the eyes. Of course, any concentrated and sustained visual activity can be tiring. If you have questions on eye fatigue or visual discomfort, consult a vision care specialist for advice.

**Note:** The example shown here is of someone in a traditional setting. Even when not in such a setting, you can follow many of these tips. Develop good habits, and they will serve you well.

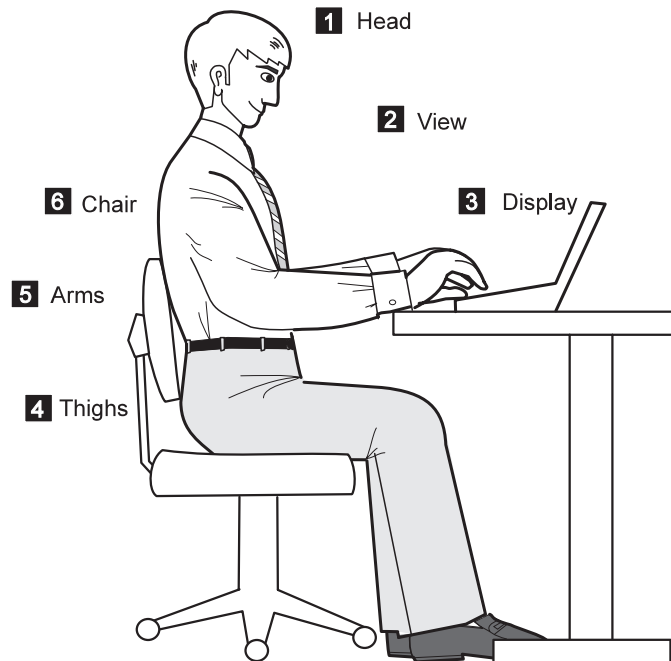

## Using Your Computer Comfortably and Safely

- 1 Head**  
Keep your head in a comfortable and vertical position.
- 2 View**  
Maintain a comfortable viewing distance of 510–760 mm (20–30 in.).
- 3 Display**  
Position the display to avoid glare or reflections from overhead lighting or outside sources of light.  
  
Keep the display screen clean and set the contrast and brightness to levels that allow you to see the screen clearly.
- 4 Thighs**  
Keep your thighs parallel to the floor and your feet flat on the floor or on a footrest.
- 5 Arms**  
Keep your forearms, wrists, and hands in a relaxed and neutral position. Don't pound the keys; type with a soft touch.
- 6 Chair**  
Use a chair that gives you good back support.

## Ruggedized Mobile Computers

Some mobile professionals need a system for managing and communicating information from the field, in environments that may require special ruggedized features to protect their computers from extreme temperature, humidity, and physical punishment. Construction, public service, distribution, repair service, and utilities are some of the environmentally demanding professions that may require rugged mobile computers that can withstand stresses. IBM offers computers (not ThinkPad Systems) for these environments.

For more information on these computers, consult your IBM Business Partner or visit our website at [www.networking.ibm.com/wireless](http://www.networking.ibm.com/wireless).

## For More Information

For information from the World Wide Web:	<a href="http://www.us.pc.ibm.com/thinkpad">www.us.pc.ibm.com/thinkpad</a>
For product and dealer location information:	<a href="http://www.networking.ibm.com/wireless">www.networking.ibm.com/wireless</a>
To access the IBM PC Company Bulletin Board:	1 800 426-2968
	1 919 517-0001

***Using Your Computer Comfortably and Safely***

For product information sent	1 800 IBM-3395
directly to your fax machine:	(1 800 426-3395)
IBM PC Product Guide Directory	Select FaxDoc #12745
(to specific product sections):	
IBM ThinkPad Information	Select FaxDoc #11078
Directory:	

*Using Your Computer Comfortably and Safely*



## Chapter 2. Operating Your Computer

---

This chapter provides information about the computer's high-technology features.

Increasing Memory Capacity	40
Replacing the Hard Disk Drive	44
Using an External Pointing Device	48
Disabling the TrackPoint III	51
Switching between the LCD and an External Monitor	52
Attaching the Monitor	52
Using SVGA Video Mode	56
Using a PC Card	58
Installing the PC Card	59
Installing the PC Card Device Driver	61
Installing the PC Card Modem	63
Using CardWorks	66
Self-Check	68
PC Card Information	68
Attributes	69
Resources	70
Drivers	70
Stopping the PC Card	72
Help	72
Using the Audio Features	73
Using the 3D Sound Retrieval System (SRS) Function	74
Using Infrared Communication	77
Using a Port Replicator	80
Attaching Your Computer to the Port Replicator	80
Enabling the CardBus Sockets (for Windows 95 Only)	83
Detaching Your Computer from the Port Replicator	84

## *Increasing Memory Capacity*

# Increasing Memory Capacity

Increasing memory capacity is an effective way to make programs run faster. You can increase the amount of memory in your computer by installing a *dual inline memory module (DIMM)*, available as an option.

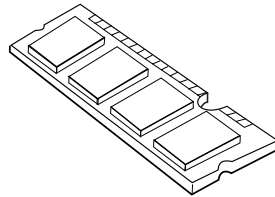

Different capacities of DIMM (up to 64 MB) are available. You can install a DIMM directly in the memory slot on the bottom of the computer. Your computer memory capacity can be expanded up to 96 MB (32-MB base memory and a 64-MB DIMM option).

- 1** Turn off the computer; then disconnect the AC Adapter and all cables from the computer.
- 2** Turn the computer over and remove the battery pack.
- 3** Loosen the screw on the memory slot cover and remove the cover.

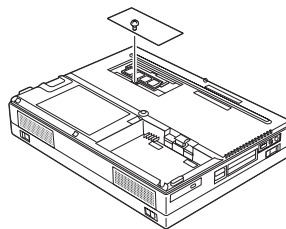

## Increasing Memory Capacity

### 4 Install the DIMM into the memory slot.

#### Attention

To avoid damaging the DIMM, do not touch its contact edge.

- a** Find the notch on the side of the DIMM.
- b** With the notched end of the DIMM toward the rear side of the socket, insert the DIMM, at an angle of approximately 20°, into the socket; then press it firmly 1 .
- c** Pivot the DIMM 2 until it snaps into place.

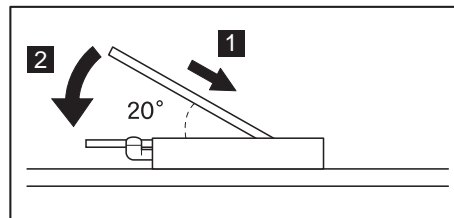
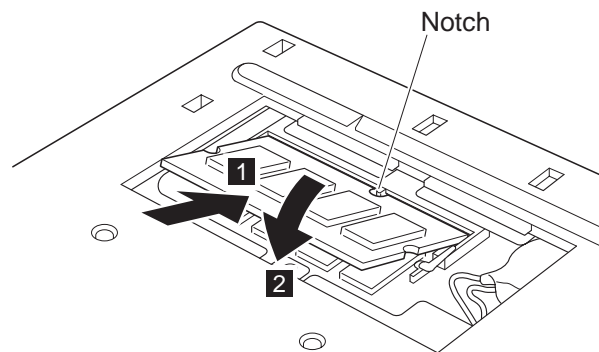

## Increasing Memory Capacity

**5** Place the memory slot cover over the memory slot; then install the screw back into its place.

**6** Turn the computer over again and confirm that the new memory size appears at the upper left corner of the screen.

For example, if you install a 32-MB DIMM, you should see the following:

```
6496 KB OK
```

You have finished installing the DIMM. Reconnect all cables.

### How to Calculate Total Memory Size

Calculate your total memory size in kilobytes (KB) by adding the DIMM memory size to the base memory size (32192 KB).

For example, if you installed a 32-MB DIMM, calculate the total memory size as follows:

**Note:** 1 MB=1024 KB

$$[32(\text{MB}) \times 1024(\text{KB})/(\text{MB})] + 32192(\text{KB}) = 6496(\text{KB})$$

#### Notes:

1. If **either** a 2 1 error code appears under the memory count,

```
48576 KB OK  
2 1
```

**or** the total memory size is not the same as the value you calculated, turn off the computer, reinstall the DIMM (see page 40) and do the memory test with Easy-Setup (see page 29).

## ***Increasing Memory Capacity***

2. If you changed the memory installed in the computer and a 195 error code appears, you need to re-create a hibernation file as follows:
  - a) Turn off the computer.
  - b) Remove the DIMM you added.
  - c) Turn on the computer and disable hibernation mode.
  - d) Add the DIMM.
  - e) Enable hibernation mode.

To disable and enable hibernation mode, refer to “Enabling Hibernation Mode.”

### **Removing the DIMM**

1. Remove the screw and memory slot cover.
2. Press out on the latches on both edges of the socket at the same time.

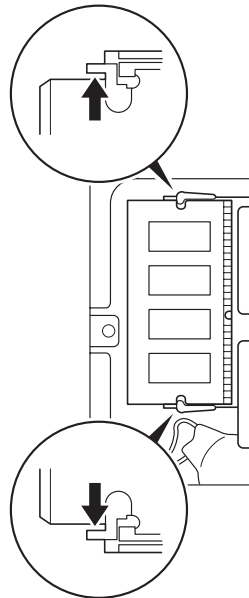

3. Remove the DIMM.  
Be sure to save the DIMM for future use.
4. Replace the memory slot cover; then replace the screw.

## Replacing the Hard Disk Drive

### Replacing the Hard Disk Drive

Your ThinkPad 380XD or 385XD computer is shipped with a hard disk drive. The following procedure describes how to replace the original drive with an optional one.

#### Attention

To prevent damage to the hard disk drive, make sure that computer is turned off and the AC Adapter is disconnected from the computer.

The hard disk is a delicate device that needs careful handling. If it falls onto a hard surface, severe damage can occur.

- 1** Turn off the computer; then disconnect the AC Adapter and all cables from the computer.
- 2** Open the LCD; then stand the computer on its side, and remove the screw with a coin.

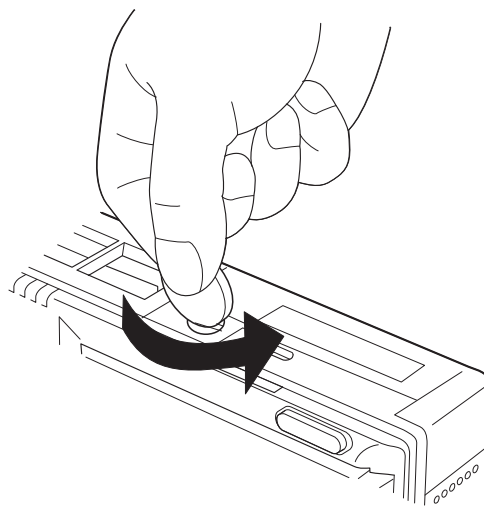

## Replacing the Hard Disk Drive

- 3** Open the hard disk drive bay cover using a coin 1 , then remove the cover 2 .

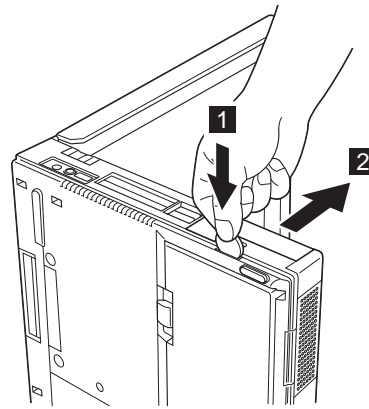

- 4** Pull the blue-strap to lift the hard disk drive 3 and remove it.

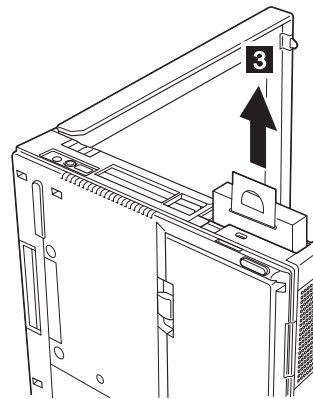

## Replacing the Hard Disk Drive

- 5** Insert the replacement drive with the strap side towards the bottom of the computer 4 .

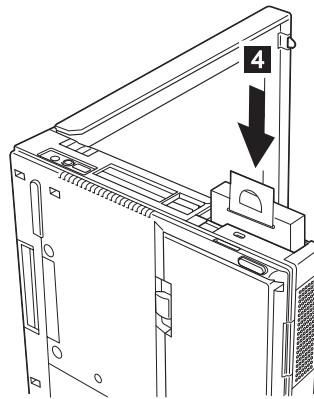

- 6** Lay the strap down 5 , align the guides of the cover with the guides on the computer; then slide the cover onto the computer 6 .

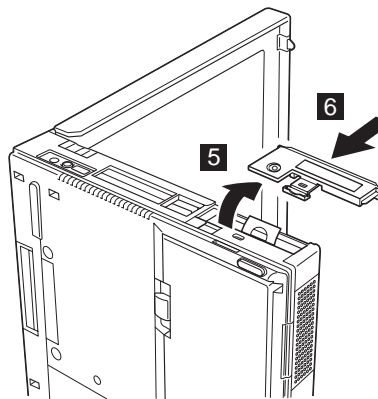



## *Replacing the Hard Disk Drive*

- 7** Reinstall the screw. You have finished replacing the hard disk drive.

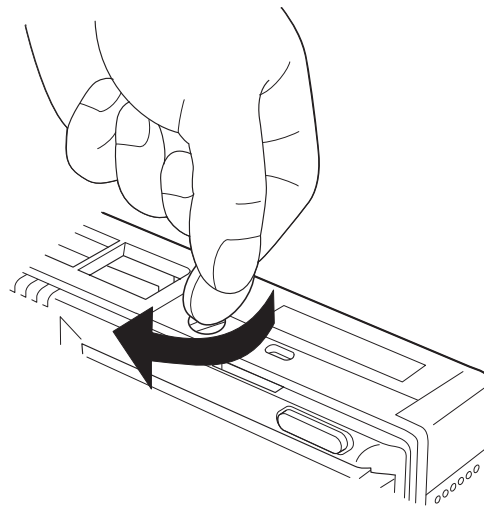

- 8** Turn the computer back to its ordinary position. Connect the AC Adapter to the computer; then turn on the computer.

**Note:** After removing the original hard disk drive, store it in the carrying case that contained the replacement drive.

*Using an External Pointing Device*

## Using an External Pointing Device

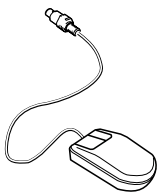

Mouse



Numeric keypad

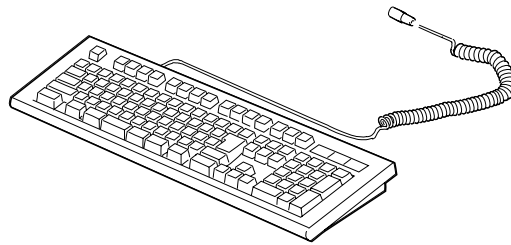

External keyboard

You can attach an external numeric keypad or a mouse directly to the external-input-device connector (🖱️) on the rear of the computer.

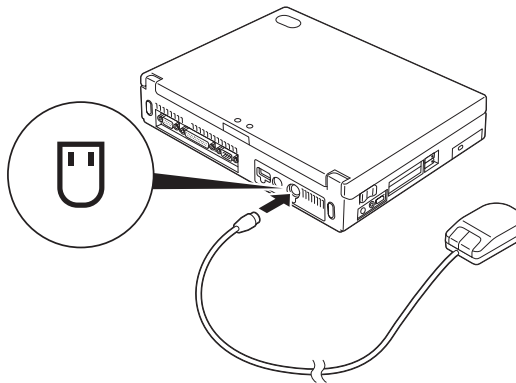

## Using an External Pointing Device

### Attaching a Mouse

You can use *both* the IBM PS/2 Miniature Mouse and the TrackPoint III as the pointing device. If you are connecting a mouse other than an IBM PS/2 Miniature Mouse, first turn off the computer. Then go to “Disabling the TrackPoint III” on page 51.

If you want to use the external numeric keypad and mouse at the same time, first connect the keypad cable to the computer; then connect the mouse cable **1** to the connector at the rear of the keypad.

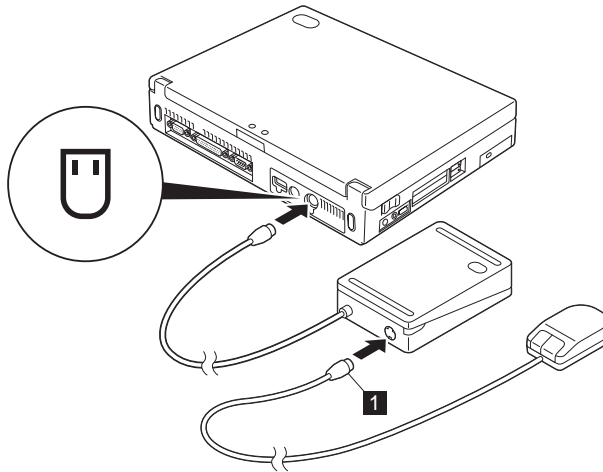

#### Note:

You can remove the keypad cover and use it as a stand for the keypad.

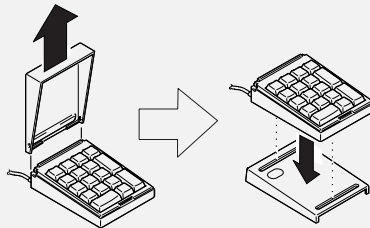

## Using an External Pointing Device

You can connect an external keyboard to your computer through the keyboard/mouse cable (available separately as an option). ***It will not work if it is connected directly to the computer.***

When the external keyboard is attached, the following are not available:

- The numeric keypad on the computer keyboard
- The external numeric keypad

Instead, use the numeric keypad on the external keyboard.

When you attach the external keyboard, turn off the computer, attach the keyboard to the keyboard port of the keyboard/mouse cable 1 , and then attach the keyboard/mouse cable to the computer 2 .

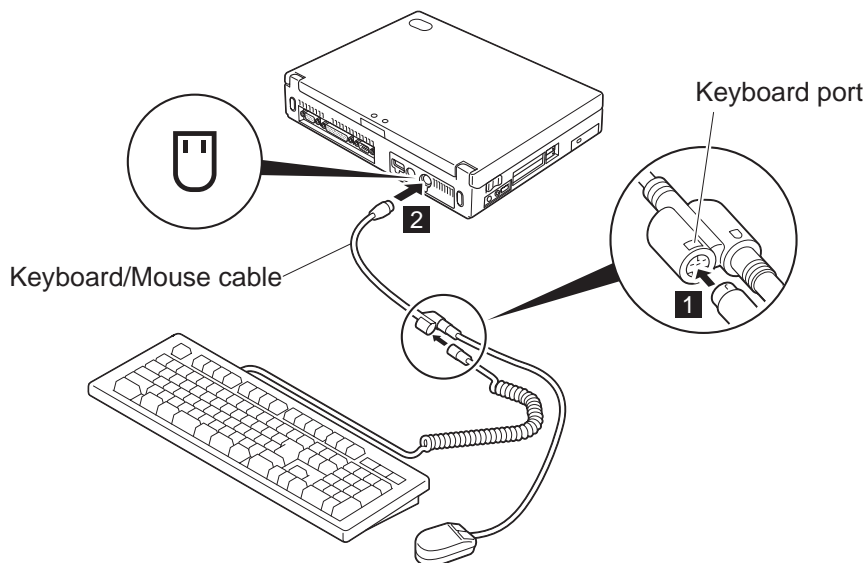

**Note:** A mouse, an external keypad, and external keyboard are optional.

## Disabling the TrackPoint III

A serial mouse connected to the serial port or a device that is incompatible with the PS/2 Mouse can be connected to the external-input-device connector. Some mouse types require the TrackPoint III to be disabled before you can use them.

To disable the TrackPoint III:



### For Windows 95:

- 1 Start the ThinkPad Configuration program.
- 2 Click on the **TrackPoint** () button.
- 3 Click on **Disable** for the TrackPoint.

These changes become effective when computer power is turned off and then on again.



### For Windows NT, Windows 3.11, and OS/2:

- 1 Start the ThinkPad Configuration program.
- 2 Click on the **Keyboard/TrackPoint** () button.
- 3 Click on **Disable** for the TrackPoint.

These changes become effective when computer power is turned off and then on again.

### Using the IBM ThinkPad Space Saver Keyboard

When using the IBM ThinkPad Space Saver Keyboard, **do not** install the device driver supplied with the Space Saver Keyboard. When the Space Saver Keyboard is used, the device driver on the computer's utility diskette automatically enables or disables the TrackPoint III of the computer when power is turned on.

## Switching between the LCD and an External Monitor

# Switching between the LCD and an External Monitor



This section provides information about using the computer LCD and an external monitor. It also provides considerations when using DOS applications.

The LCD of your computer uses thin-film transistor (*TFT*) technology or high performance addressing (*HPA*) technology. Both types of LCDs display output with SVGA (800-by-600 resolution) video mode and 16M colors.

When you attach an external monitor that supports resolution higher than VGA mode, you can get a maximum of 1024-by-768 video resolution.

## Attaching the Monitor

The following summarizes how to attach an external monitor:



- 1** Turn off the computer.
- 2** Connect the external monitor to the external monitor connector () on the rear of the computer; then connect it to an electrical outlet.
- 3** Turn on the external monitor and the computer.
- 4** Start the ThinkPad Configuration program.
- 5** Change the display output type by clicking on the **Both** () button or the **External Display** () button.

**Note:** If you select the **Both** button, do not attach an external monitor that supports only VGA mode (640-by-480 resolution). Otherwise, the external monitor screen is scrambled and the output is not displayed, or the screen might be damaged. Use **External Display** instead.

### *Switching between the LCD and an External Monitor*

- 6** Set your monitor type and display device driver as follows.

If you are attaching an SVGA monitor, refer to “Using SVGA Video Mode” on page 56 for information on the supported color depth or resolution.

**a)** Click on the **Display** ( or  ) button.

**b)** Click on the **Advanced Properties..** button.

You can select your display type from the monitor list, or click on a new resolution or refresh rate.

**Note:** Refer to the specifications for your external monitor to determine its supported resolutions and refresh rates.

- 7** Restart the computer to make the changes effective.

## Switching between the LCD and an External Monitor

### ATTENTION

Do not change the LCD type while a moving picture is being displayed, for example, when playing a movie or a game. Stop the application before changing the LCD type.

### Changing the LCD Type

You can change the display output type with the ThinkPad Configuration program. Select one of the following display output types:

**LCD** (  ): The computer output is displayed only on the LCD of the computer.

**External Monitor** (  ): The computer output is displayed only on the attached external monitor.

If no external monitor is attached to the computer and the display output type is set to *External Display*, the output is displayed on the LCD.

**Both** (  ): The computer output is displayed on both the LCD and the external monitor.

You can also change the display output type as follows:

Using the **Fn** key function:

Press and hold the **Fn** key; then press the **F7** key. The output is displayed sequentially as follows:

```
External    Both
Display

LCD
```

Using the PS2 Command:

For DOS, use the PS2 command to change the display output type.

- Type `PS2 SC BOTH` to display information on both the LCD and external monitor.
- Type `PS2 SC CRT` to display information only on the external monitor.
- Type `PS2 SC LCD` to display information only on the LCD.



## ***Switching between the LCD and an External Monitor***

### **Important**

If you are using OS/2 Warp, do not use **System** in the System Setup folder to change the resolution or color depth. Use the ThinkPad Configuration program to configure the monitor.

**Do not disconnect the external monitor while the computer is in suspend mode or hibernation mode. If no external monitor is attached when the computer resumes, the LCD remains blank and the output is not displayed. This restriction does not depend on the resolution value.**

### **Virtual Screen Function**

The *virtual screen* function is available with the ThinkPad Configuration program. It is used to display a part of the high-resolution screen image that is produced by your computer. Other parts can be seen by moving the screen with the TrackPoint III or other pointing device. The virtual screen can be disabled on Windows 3.11 with the ThinkPad Configuration program. In this case, restart your computer to make the screen size fit the display.

## Switching between the LCD and an External Monitor

### Considerations for DOS Screen on the LCD

When you use a DOS application that supports only VGA mode (640-by-480 resolution) with your computer, the screen image might appear smaller than the display size, as shown:

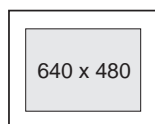

This is to maintain compatibility with DOS applications. To expand the screen image to the same size as the actual screen, you can use the *screen expansion* function. You can expand the screen image by clicking on the **Display** button (  ) in the ThinkPad Configuration program or by entering the `PS2 HVEXP ON` command. However, the image may look slightly distorted.

## Using SVGA Video Mode

Your ThinkPad 380XD or 385XD computer has an LCD that supports an SVGA video mode with 800x600 resolution. You can also display information in higher resolutions by attaching an external monitor that supports higher resolutions. The following table shows the various display modes (resolution and color depth) available with your computer or external monitor. Use this table to set the display output (**LCD**, **External Display**, or **Both**).

### Note:

When installing an operating system, you must install the display driver supplied with the computer to use SVGA mode.

### ***Switching between the LCD and an External Monitor***

Displaying output on the LCD or both on the LCD and external monitor (**LCD** or **Both**)

<b>Panel Type</b>	<b>Resolution</b>	<b>Supported Color Depth</b>	<b>Frame Rate to External Monitor (Both)</b>
800x600 TFT	800x600	16; 256; 65,536; and 16,777,216	60 Hz
800x600 TFT	640x480	16; 256; 65,536; and 16,777,216	60 Hz
800x600 HPA	800x600	16; 256; 65,536; and 16,777,216	60 Hz
800x600 HPA	640x480	16; 256; 65,536; and 16,777,216	60 HZ

Displaying output only on the external monitor (**External Display**)

<b>Resolution</b>	<b>Supported Color Depth</b>	<b>Frame Rate</b>
640x480	16; 256; 65,536; and 16,777,216	60 Hz, 75 Hz, or 85 HZ
800x600	16; 256; 65,536; and 16,777,216	60 Hz, 75 Hz, or 85 HZ
1,024x768	16; 256; and 65,536	60 Hz or 75 Hz

## Using a PC Card

# Using a PC Card

This section describes how to insert a PC Card.

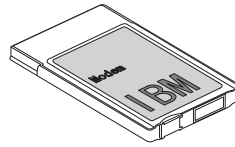

Your computer has two PC Card slots (upper slot and lower slot) and supports the following types of cards:

- PC Card (Type I, Type II, and Type III)

- CardBus

- Zoomed Video (ZV)

You can insert a *Type I* or *Type II* PC Card one in either slot (you can insert cards in both slots), a single *Type III* PC Card in the lower slot.

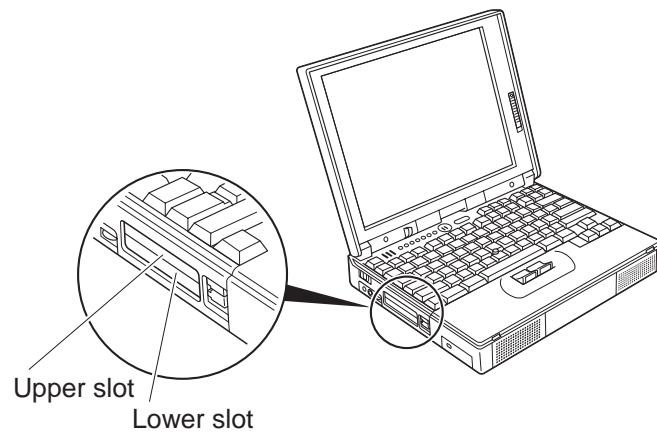

## Installing the PC Card

- 1 Find the notched edge 1 of the PC Card as shown.

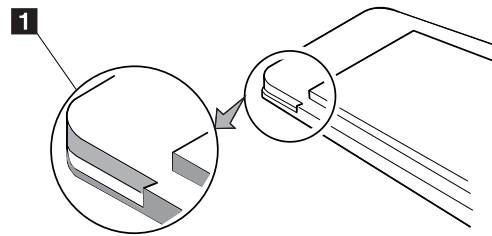

- 2 Insert the PC Card into the appropriate slot according to your PC Card type.

**Note:**

If you are using a PC Card with an XJACK\*\* connector, insert it into the upper slot.

If you are using a Type I or Type II PC Card, insert it into either the upper slot or the lower slot.

If you are using a Type III PC Card, insert the card into the lower slot.

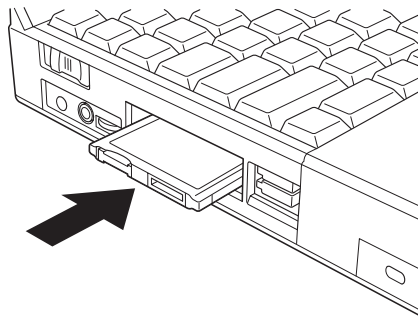

## Using a PC Card

- 3** Press the PC Card firmly into the connector until the eject button pops out. Then, pull the eject button out slightly **1** and fold it to the right **2**.

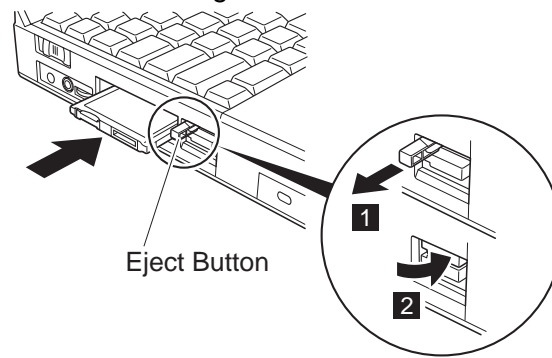

**Note:** If you use the PC Card in Windows 95, do the following procedures. If you use the PC Card in other operating system, see the online book.

Unless you are installing a PC Card modem, the following CardWizard\*\* information panel pops up and informs you about the new card:

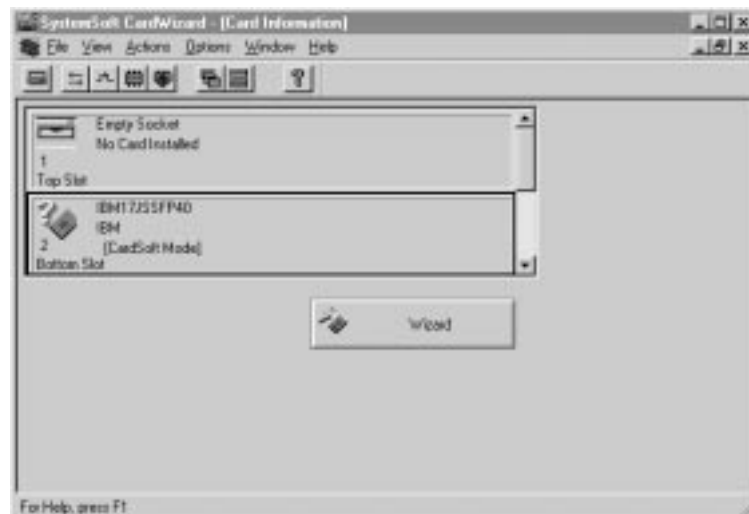

## Using a PC Card

If you are installing a PC Card modem, “Location Information” windows appears. Go to “Installing the PC Card Modem” on page 63.

### Note

If CardWizard does not have the device driver of the PC Card, the following “Select Installation Preference” window appears prompting you to install the driver. Go to “Installing the PC Card Device Driver .”



## Installing the PC Card Device Driver

Install the device driver as follows:

- 1 Make sure that **Have diskette provided by card manufacturer** is selected. Click on **OK** in the “Select Installation Preference” window.

The following window appears:

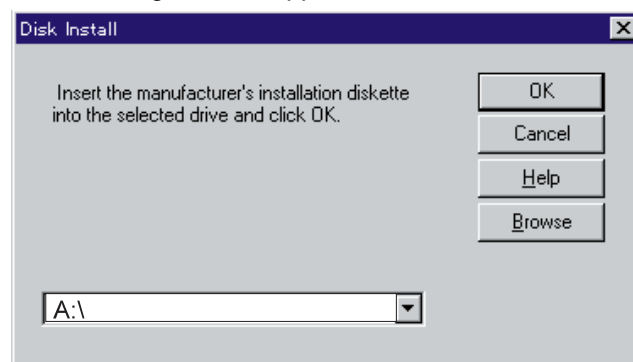

## *Using a PC Card*

**2** Insert the device driver (or option) diskette supplied by the PC Card manufacturer into the diskette drive.

**3** Follow the instructions in the manual that came with the PC Card.

**Note:** If CardWizard does not recognize your PC Card and you cannot install the PC Card device driver, you need to copy necessary INF files of the the PC Card device driver (or option) diskette to your `c:\WINDOWS\INF` directory prior to let CardWizard detect the PC Card.



## Installing the PC Card Modem

### Attention

Your computer can be connected only to a public telephone line (**analog line**). Do not use a digital telephone line. Use of a phone line other than an analog can damage your modem.



### Danger:

To avoid shock hazard, do not connect the cable to or disconnect the cable from the telephone outlet on the wall during electrical storms.

When you install the PC Card modem in Windows 95, the “Location Information” window appears:



Do as follows:

- 1** Fill in the necessary information.
- 2** Click on **OK**.

## Using a PC Card

- 3 Release the telephone jack socket on the PC Card modem.

For example, push the push-pop of the PC Card modem 1. For other types of the modem, follow the instructions in the manual supplied with the modem.

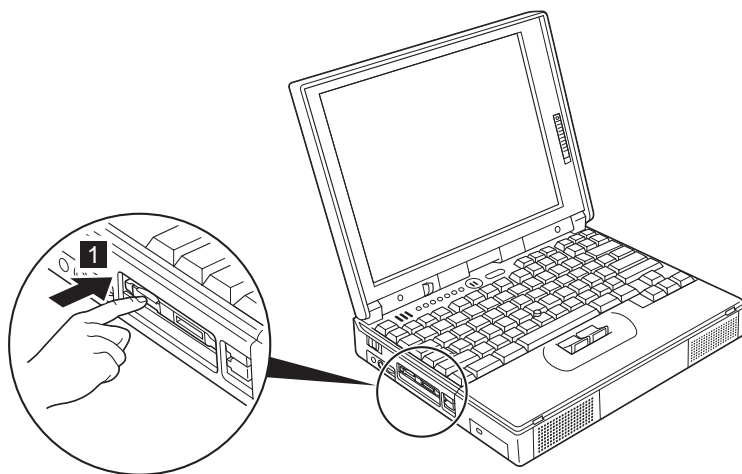

- 4 Connect one end of the telephone cable to the PC Card modem 1 and the other end of the cable to a telephone outlet 2.

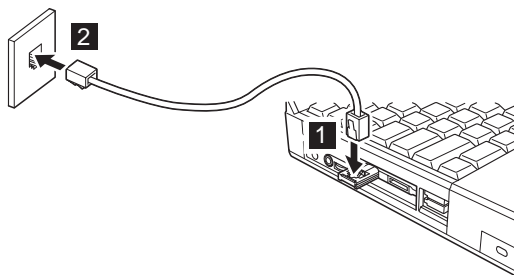

**Note:** If your ThinkPad shares a single telephone cable with a telephone, use the cable supplied with your computer.

You have completed setting up the PC Card modem.

## Using a PC Card

**Note:** If the “Location Information” window does not appear, you need to set up the modem by clicking on **Start** and moving the cursor on **Settings; Control Panel**, then double-clicking on **Modem**.

For details on PC Card Support Software, go to “Using CardWorks” on page 66.

### Removing the PC Card

For a network modem, stop the PC Card before removing the PC Card from the PC Card slot (see “Stopping the PC Card” on page 72).

Raise the PC Card eject button 1 for the PC Card you want to remove. Then, press the PC Card eject button 2 until the PC Card pops out.

Remove the PC Card and save it for future use.

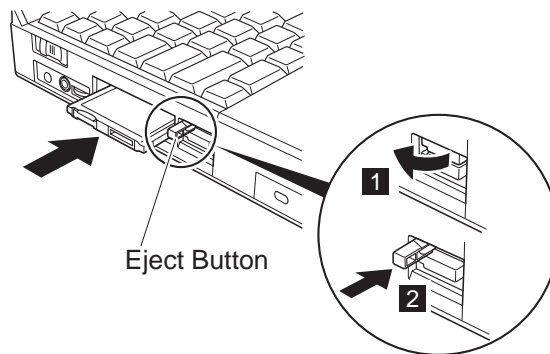

## Using CardWorks

If your computer is preloaded with Windows 95, you can make your PC Card easy to use with the PC Card support software called CardWorks. For information on PC Card support software for other operating systems, refer to the online book.

CardWorks minimizes user intervention in configuring many PC Cards. CardWorks with CardWizard provides the following:

### **Capability to check**

When you have some trouble, refer to this section.

→ Self-Check

### **PC Card information**

CardWorks provides the various information about your PC Card.

→ PC Card Information

### **Capability to stop**

When you remove the PC Card from your computer, sometimes you need to stop the PC Card.

→ Stopping the PC Card

### **Help**

You can get help for most of the windows.

→ Help

CardWorks provides two modes for using a PC Card:

### **Plug and Play mode:**

You can use the PC Card in this mode when the device driver of the card is supported by Windows 95.

**CardSoft mode:**

You can use the PC Card in this mode when the device driver of the PC Card is for Windows 3.11.

To start CardWizard, do as follows:

- 1** Click on **Start**.
- 2** Move the cursor to **Programs** and **CardWorks**. Then click on **CardWizard**.

The CardWizard window appears:

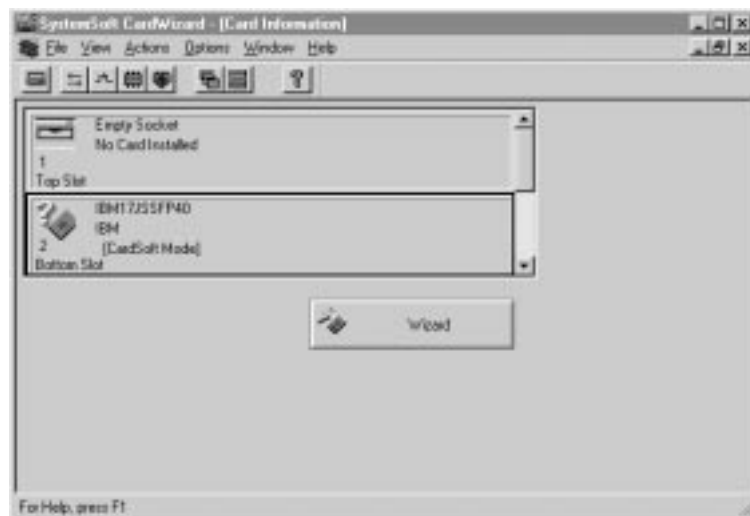

The information panel displays up-to-date information about the PC Cards and PC Card slots being used in your computer.

It also displays up to three lines of card information, which it reads directly from the card:

- The first line shows the card name.
- The second line shows the manufacturer.
- The third line shows the card's function or type.

## Self-Check

CardWorks has a self-check function that solves such problems as incorrect or missing PC Card device drivers, system resource conflicts (IRQ, memory, or I/O ports), and unconfigured PC Cards, as well as memory conflicts.

If there are any problems, click on the **Wizard** button. Each time you click on the **Wizard** button, a series of self-checks is run to assure that all necessary components are installed and working properly. CardWizard then analyzes the computer to verify that there are resources available for PC Card configuration.

Even if CardWizard cannot automatically solve a problem, it can pinpoint the problem exactly so that you or a technical support engineer can fix the problem more easily.

## PC Card Information

You can see the attributes, resources, drivers, and use some of PC Card utilities in the "PC Card Properties" window.

To open the "PC Card Properties" window of the PC Card that you are using, do the following:

- 1** Select the PC Card in the CardWizard window by clicking on it.
- 2** Click on **View** in the menu bar of the window.
- 3** Click on **Properties..** in the pop-up menu.  
The "PC Card Properties" window appears.

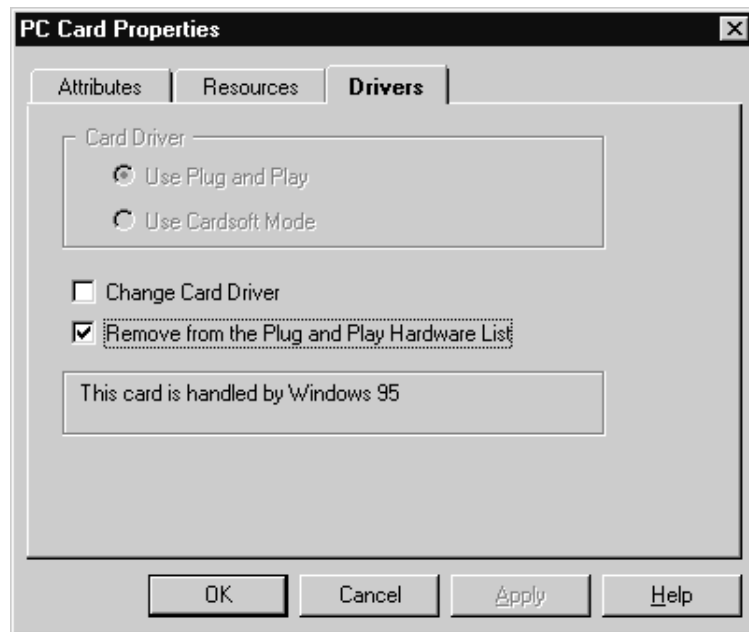

The window provides the following information:

- Attributes
- Resources
- Drivers

*Attributes*

**Note:** The following information appears depending on the type of PC Card:

- Slot: The slot number and assigned name for the slot. (You can change the slot name by selecting **slot management** from the options menu.)
- Card: The unique identification number of the module.
- Manufacturer: The manufacturer of the PC Card.
- Size: The storage capacity of the PC Card.

## Using CardWorks

Drive:	The drive letter.
Battery status:	The charge status of the SRAM Card battery.
Write protect:	The write protect status—either enabled or disabled.
File system:	The file system used by the PC storage or hard disk card.
Port:	The communication port used by this PC modem card.

## Resources

**Note:** Some resource information is not relevant to all types of PC Cards. These nonrelevant resources are displayed as “Not Applicable.”

IRQ:	The interrupt request being used.
I/O:	The starting and ending addresses of the input/output range for the PC Card.
DMA:	The DMA channel used.
Memory range:	The range of physical memory.

## Drivers

**Note:** CardWizard determines the type of device driver being used. It also displays whether the card is configured by Windows 95 or by CardWorks.

Card driver:	Indicates whether Plug and Play mode or CardSoft mode is used in configuring the PC Card. This field is enabled only if the <b>Change card driver</b> box is checked. You should <i>not</i> change drivers if your card has been identified and configured successfully.
--------------	--



## *Using CardWorks*

### Change card driver:

If this item is enabled (checked), you can select either Plug and Play (if available) or the CardWorks device drivers.

### Remove from the Plug and Play hardware list:

If this item is enabled (checked), you can delete the Plug and Play device driver assigned to a card. This applies only if the card is handled by Windows 95 (Plug and Play mode). Later, when you reinsert the same PC Card, CardWorks configures the card as if it were the first insertion.

### Memory Card Utility:

This item appears only if you insert an SRAM card or a Flash memory card. You can format the SRAM card or Flash memory card as follows:

**Note:** You can also format these card from the file system with the DOS FORMAT command.

1. Open the "PC Card Properties" window.
2. Select **Memory Card Utility** tab.
3. Enter a **Volume Label** (if desired).
4. Click on **Format Drive/Partition**.
5. Click on **Start**.

This procedure enables you to completely erase a SRAM/Flash memory card, especially a brand-new card. Make sure to save the data on the card before erasing it.

## Stopping the PC Card

If you are removing a PC Card, you must first stop it. The system might freeze or data might be lost if a PC Card is removed before it is stopped.

**Note:** You can stop only one card at a time. After stopping a card, you cannot stop another card until the first card has either stopped completely or failed.

You can stop a card as follows:

- 1** Click on the right button on the CardWizard window.

A pop-up menu appears.

**Note:** The stop option appears in gray if you are in CardSoft mode or if the card is already stopped.

- 2** Click on **Stop**. The following message appears:

The card has been stopped. You can safely remove the card.

If the stop fails, no message appears.

## Help

If you press **F1** or select the **Help** button, a glossary of terms and an index of Help items are made available.

## Using the Audio Features

Your computer is equipped with the following:

An  $\frac{1}{8}$ -inch (3.5-mm) diameter input jack to connect an external stereo line-in device or a monaural microphone.

**Note:** To use the input jack for an external stereo line-in device, you need to disable the microphone function with software on your operating system. For example in Windows 95, you can disable the function by checking **Mute** for **MIC** in the "Master Out" window(see page 74). To use the jack for a monaural microphone, disable the line-in function with software.

An  $\frac{1}{8}$ -inch (3.5-mm) diameter output jack to connect a stereo headphone or an external-powered speaker jack.

A MIDI/joystick port on the port replicator. To use a MIDI device, you should first connect your computer to a port replicator; then connect an external MIDI device to the port replicator. After docking your computer in the port replicator, you should enable this port using the ThinkPad Configuration program.

Two high quality stereo speakers and a subwoofer.

Your computer also has an audio chip that enables you to enjoy various multimedia audio features. This audio chip provides the following features:

Recording and playing back of PCM and WAV files in 8-bit or 16-bit format.

Sampling of various rates from 5 KHz to 44 KHz for the WAV file.

Playback of MIDI files through an FM synthesizer.

Recording from various sound sources, such as an integrated microphone, an external microphone, or an audio device attached to a line-in jack or an integrated CD-ROM drive.

## Using the Audio Features

DOS game compatibility. You should select Sound Blaster Pro\*\* for the audio adapter in the sound setup of the game.

The 3D Sound Retrieval System (SRS) function. It compensates for the flat, two dimensional sound image limitations by reestablishing the necessary information that allows the human ear to hear in three dimensions.

### ATTENTION

Do not enter suspend or hibernation mode when you are using audio features. You need to restart or resetup the application for continuous use.

## Using the 3D Sound Retrieval System (SRS) Function

To use the SRS function, do the following:

- 1 Double-click on the small speaker icon (  ) at the bottom right of the Windows desktop.

*or*

Click on the **Start** button, and then select **Programs**, **Accessories**, **Multimedia**, and **Volume Control**.

The “Master Out” window appears:

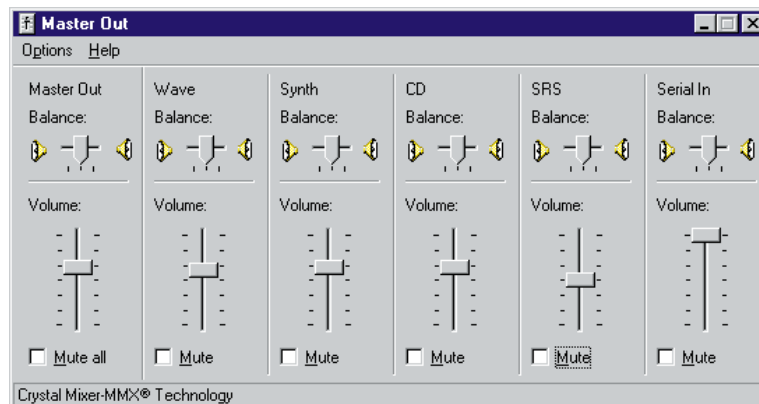

**2** Is the **SRS Balance** column displayed?

**Yes.**

- a) Make sure that the **Mute** checkbox is unchecked.
- b) Exit the window. You can use the SRS function; skip the remaining step.

**No.**

Select **Options** on the upper left corner of the window and select **Properties**. The “Properties” window appears:

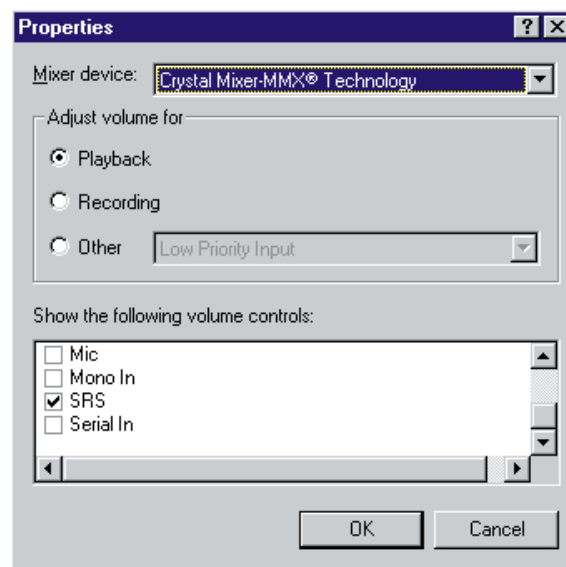

**3** Put a check mark on **SRS** and press **OK**.

You return to the “Master Out” window.

**4** Make sure that the **Mute** checkbox is unchecked.

**5** Exit the “Master Out” window.

### ***Using the Audio Features***

Now you can use the SRS function.

## Using Infrared Communication

The infrared communication technology allows wireless point-to-point communication with other ThinkPad computers or systems equipped with an infrared port. The infrared port can communicate at a distance of up to approximately 1 meter (3.3 ft.) at a rate of up to 4 megabits per second (Mbps).

Your ThinkPad computer has an infrared port that can communicate with another ThinkPad computer.

To use the infrared communication, the IR ports of both computers must be enabled through the ThinkPad Configuration program.

- 1** Enable the IR port as follows:
  - a)** Start the ThinkPad Configuration program.
  - b)** Click on **Infrared** button ().
  - c)** Select **Enable**; then click on **OK**.
- 2** Click on **Start**.

## Using Infrared Communication

- 3 Move the cursor to **Programs**, **TranXit**, and click on **TranXit**.

The “TranXit” window appears:







## Using a Port Replicator

Your ThinkPad 380XD or 385XD computer is supported by the following port replicators:

ThinkPad 560 Port Replicator  
ThinkPad 380 or 385 Port Replicator  
ThinkPad Enhanced Port Replicator

After you attach your computer to the port replicator, all connectors on the rear of the computer are covered and are not available for use. Instead, you can use the connectors on the port replicator, plus extra features.

### Important

The port replicator works only with AC power. You cannot use the port replicator with battery power from the computer.

## Attaching Your Computer to the Port Replicator

The system-expansion connectors at the bottom of your computer allow you to attach it to the port replicator. This section describes how to attach your computer.

**1** Disconnect the AC Adapter from the wall outlet and from the computer.

**2 For Windows 95:**

Press **Fn+F4** and close the LCD, or turn off the computer and close the LCD. You can attach the computer to the port replicator **while the computer is in suspend mode or when the computer power is turned off.**

## *Using a Port Replicator*

### **For other operating systems:**

Turn off the computer and close the LCD. You can attach the computer to the port replicator only **when the computer power is turned off.**

- 3** Align the guide holes on bottom of the computer with the guide hooks on the port replicator and the connectors.

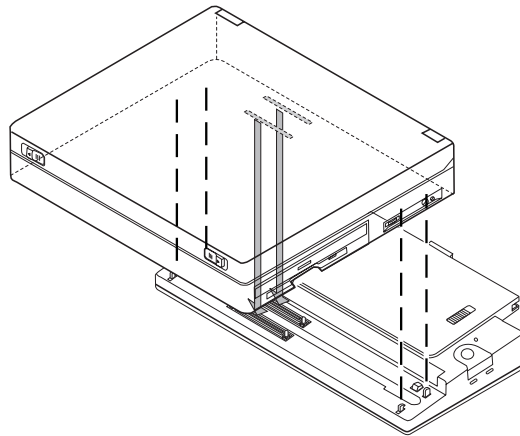

- 4** Press the top of the computer so that the connectors and guide pins are firmly connected to the port replicator.

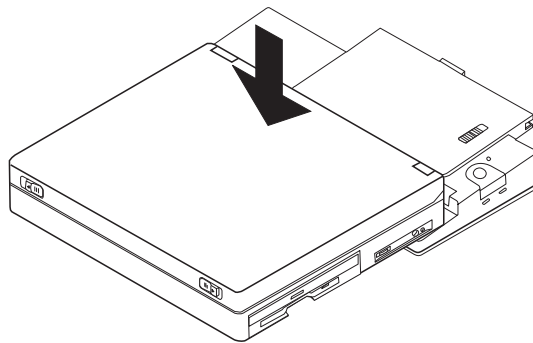

## Using a Port Replicator

- 5 Connect one end of the AC Adapter to the port replicator and the other end to the wall outlet.

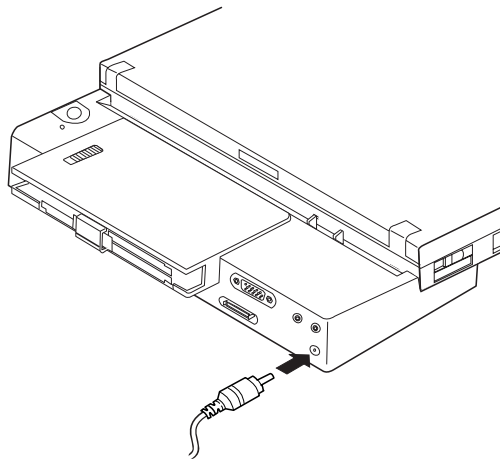

- 6 **For Windows 95:**  
Open the LCD or open the LCD and turn on the computer.

**For other operating systems:**

Turn on the computer and open the LCD.

When the computer is turned on, the power-on indicator on the port replicator turns on.

**Note:** If the power-on indicator of the computer or the port replicator does not turn on, press **Fn**.

- 7 To prevent your computer from being removed from the port replicator, attach a security system lock to the security system lock hole on the side of the port replicator.

## *Using a Port Replicator*

### **Important**

Do not remove the AC Adapter while you are using the port replicator. Removing it during use may cause the computer to malfunction.

### *Enabling the CardBus Sockets (for Windows 95 Only)*

The port replicator might not function properly when you attach a computer to it that is in suspend mode. In such a case, enable the CardBus sockets by doing the following:

- 1** Click on **Start** and move the cursor to **Settings** and then click on **Control Panel**.
- 2** Double-click on **System**.
- 3** Click on **Device Manager** and **PCMCIA socket**. You will see two **Texas Instruments PCI-1131 CardBus controller** lines with an exclamation mark (!) under **PCMCIA socket** if the CardBus sockets are not enabled.
- 4** Click on one of the lines. Then click on the **Remove** button.
- 5** Click on the other line. Then click on the **Remove** button.
- 6** Click on the **Refresh** button.

The CardBus sockets are now enabled.

## Detaching Your Computer from the Port Replicator

### Important

Remove all security system locks from the port replicator before you detach the computer.

### 1 For Windows 95:

Press **Fn+F4** and close the LCD, or turn off the computer and close the LCD. You can detach the computer from the port replicator **while the computer is in suspend mode or when the computer power is turned off.**

### For other operating systems:

Turn off the computer and close the LCD. You can detach the computer from the port replicator only **when the computer power is turned off.**

- 2** Disconnect the AC Adapter from the wall outlet and from the port replicator.
- 3** Make sure the power-on indicator on the port replicator is off. The release latch cannot be pressed and the computer cannot be removed from the port replicator while this indicator is on.
- 4** Press the release latch  on the port replicator; then remove the computer.

## *Using a Port Replicator*

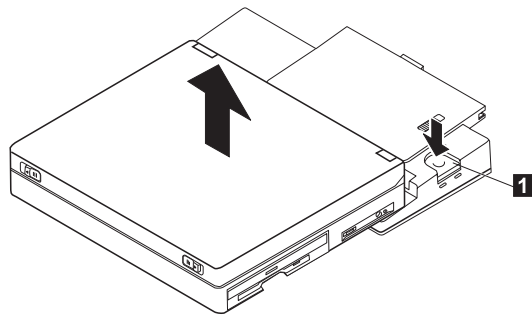

**5** Connect the AC Adapter to your computer.

**6** Connect the AC Adapter to the wall outlet.

**Note:** For details about other functions of the port replicator, refer to its manual.

## *Using a Port Replicator*



## Chapter 3. Using Battery Power

---

This chapter describes battery pack operations.

Using the Battery Pack . . . . .	88
Charging the Battery Pack . . . . .	88
Monitoring the Battery Status . . . . .	88
Using the Battery Status Indicator . . . . .	89
Using the Fuel-Gauge Program . . . . .	92
Saving Battery Power . . . . .	93
Using the Power Management Modes . . . . .	93
Customizing Power Management . . . . .	99
Setting the Screen Off Timer or the Suspend Timer . . . . .	99
Enabling Hibernation Mode . . . . .	101
Considerations When Using a Power Management Mode . . . . .	102
Considerations for Suspend Mode . . . . .	102
Considerations for Hibernation Mode . . . . .	104
Considerations When Installing or Reinstalling the Operating System . . . . .	106
Using Other Battery-Saving Methods . . . . .	108
Replacing the Battery Pack . . . . .	109

## Using the Battery Pack

This section describes how to charge your battery pack, display its status, or replace it.

### Charging the Battery Pack

You can charge the battery pack when the AC Adapter is connected to the computer and the battery pack is installed. You must charge the battery pack in any of the following conditions:

- If you purchase a new battery pack
- If the battery status indicator starts blinking
- If the battery pack has not been used for a long time

**Notes:**

1. Before you charge the battery pack, ensure that its temperature is at least 10°C (50°F).
2. If the battery pack has not been used for a long time, it will not be fully charged with only a single charging. You will have to completely discharge it; then recharge it three to six times to maximize battery operating time.

### Monitoring the Battery Status

You can monitor the battery status through the battery status indicator and the Fuel-Gauge program.

## Using the Battery Pack

### Using the Battery Status Indicator

The battery status indicator shows the current status of the battery pack (only when the battery is installed).

Compare the battery status indicator with the following table to determine the condition of your battery.

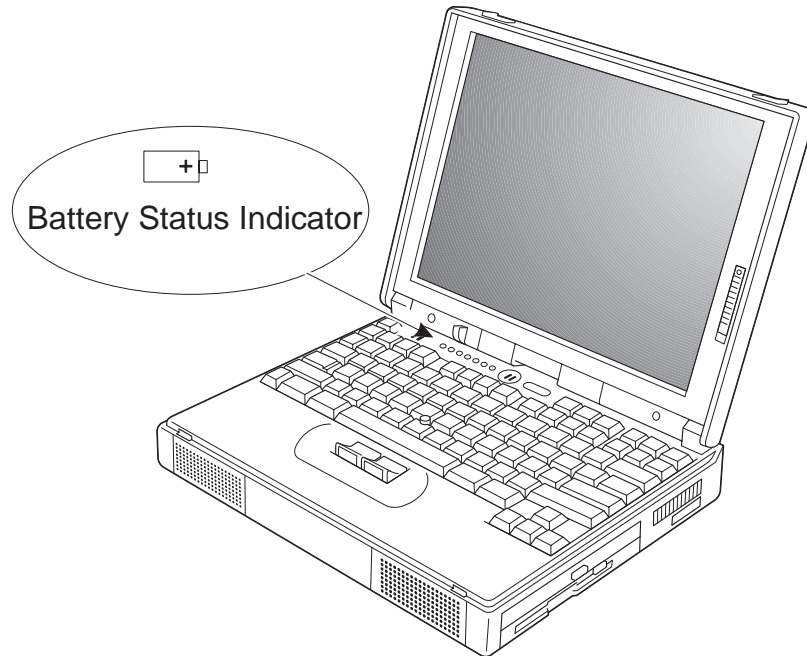

Status	Condition
Green	Enough power remains for operation.
Orange	The battery pack is being charged.
Blinking orange	The battery pack needs charging. If the indicator starts blinking orange, the computer beeps three times.
Off	The battery pack is not installed. The computer is turned off or is in suspend mode when the AC Adapter is not connected.

## Using the Battery Pack

### Attention

You need to ***immediately connect the AC Adapter to the computer*** when the battery status indicator is *blinking orange*, and your computer sounds three consecutive beeps. (If your computer enters suspend mode because of a low-battery condition, data in memory might be lost.)

After connecting the AC Adapter, take either of the following actions:

To continue your work with AC Adapter, press the **Fn** key.

**or:**

To continue your work with a fully charged spare battery pack, do the following:

1. Replace the battery pack with a fully charged one. (See “Replacing the Battery Pack” on page 109.)
2. Press the **Fn** key.
3. Disconnect the AC Adapter from the computer.

If you do not take these actions within about 30 seconds, the computer will enter suspend mode.

**Do not leave the computer in this condition for an extended time. Data in memory will be lost.**

## *Using the Battery Pack*

### **Notice**

If the computer enters suspend mode because of a low battery condition, the computer will go into hibernation mode before the battery power is completely used up. This capability is disabled as a factory default. You can enable or disable it with **Suspend/Resume Options** from **Power Management** in the ThinkPad Configuration program. If the system goes into hibernation mode, replace the battery with a fully charged one or supply the system with AC power. Do not disconnect your system from AC power until the battery is fully charged.

## Using the Battery Pack



### Using the Fuel-Gauge Program

Using the Fuel-Gauge program, you can display the battery status and power mode (High performance, Automatic, or Customized). You also can select suspend or hibernation mode.

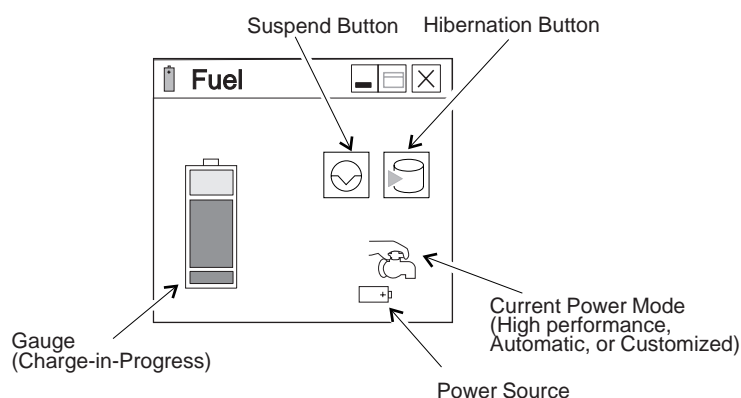
To start the Fuel-Gauge program, click on the **Fuel** icon in the ThinkPad folder. The following window appears:



#### Notes:

1. The "Current Power Mode" icon depends on the power mode.
2. The "Power Source" icon depends on the power source. (  is for the AC Adapter and  is for battery pack.)

You can minimize the window to an icon by clicking on  on the status bar of the window. You can toggle between the Fuel-Gauge window and the icon by pressing the **Fn+F2** key combination.

## Saving Battery Power

Your battery pack should be useful for approximately 3 years or 300 charge-discharge cycles. The number of years or charge-discharge cycles may vary depending on how efficiently you use your computer. This section describes the following:

- How to use the power management modes to save battery power
- How to customize power management
- Considerations when using a power management mode
- How to use other battery saving methods

### Using the Power Management Modes

Your ThinkPad computer has three power management modes to save power. You can use your computer under battery power for a considerable length of time by using these power management modes:

#### **Standby Mode**

In standby mode, the LCD and hard disk drive turn off. Also, if a power-saving monitor (Energy Star Monitor) is in use when the computer enters standby mode, the computer activates the monitor's low-power mode.

Your computer enters standby mode if one of the following conditions is satisfied:

- You press **Fn+F3**.
- The screen off timer reaches the timeout values.

**Note:** See “Customizing Power Management” on page 99.

To return to normal operation, press any key or move the TrackPoint, or other pointing devices.

#### **Suspend Mode**

In this mode, to consume very little power, your computer stops all tasks and stores all data in memory. Your

## Saving Battery Power

computer enters suspend mode if one of the following conditions is satisfied:

- You press **Fn+F4**.
- You close the LCD.
- You select the **Suspend** button (  ) in the Fuel-Gauge program.
- The battery is low.
- The suspend timer reaches the timeout values.

**Note:** See “Customizing Power Management” on page 99.

To return to normal operation, press **Fn**.

### Hibernation Mode

In this mode, your computer stops all tasks and stores all data in the hard disk; then it powers off. You should set your computer to this mode when you want to maintain the present operating condition until the next day, for instance.

To use this mode, you have to create a hibernation file with the ThinkPad Configuration program. (See “Enabling Hibernation Mode” on page 101.)

#### For Windows NT Users

You cannot create a hibernation file in a Windows NT system that uses the NTFS format, the Windows NT default. If you want to use hibernation mode, you should reinstall Windows NT with the FAT format.

Your computer enters hibernation mode if one of the following conditions is satisfied:

- You press the **Fn+F12**.
- You select the **Hibernation** button (  ) in the Fuel-Gauge program.



## ***Saving Battery Power***

- The battery is critically low.
- The hibernation timer reaches the timeout value.

**Note:** You can set the timer to enter hibernation mode in the **Suspend/Resume Options** menu when you start the ThinkPad Configuration program and then click on the **Power Management** button.

## Saving Battery Power

### RediSafe



To prevent loss of data during suspend mode when the battery is critically low, the ThinkPad has a **RediSafe** function. Once you set this function, the hibernation file is activated each time the computer enters suspend mode, and is ready to enter hibernation mode from suspend mode whenever the battery is critically low.

Set **RediSafe** as follows:

#### Windows 95:



1. Start the ThinkPad Configuration program.
2. Click on **Power Management** ().
3. Select the **Hibernation** tab.
4. Enable hibernation mode if it is disabled.
  - a) Click on the **Enable Hibernation..** button.
  - b) Click on **Create Now**; then **Close**.
5. Select **RediSafe**.
6. Click on **OK**.

#### Windows NT, Windows 3.11, or OS/2:

1. Start the ThinkPad Configuration program.
2. Click on **Power Management** ().
3. Select the **Suspend/Resume Options** button ().
4. Enable hibernation mode if it is disabled.
  - a) Click on the **Enable Hibernation..** button.
  - b) Click on **OK**.
5. Select **RediSafe**.
6. Click on **OK**.

## Saving Battery Power

The following table shows how the indicator behaves in each power management mode:

Current Status	Indicator	
	 Suspend Mode	 Power-On
Normal operation or standby mode	Off	Green
Suspend mode	Green	Off
Entering or resuming from suspend mode	Blinking green	Off
Power off or hibernation mode	Off	Off

The following figure shows the relationship between different power management modes, how to switch between them, and battery power consumption:

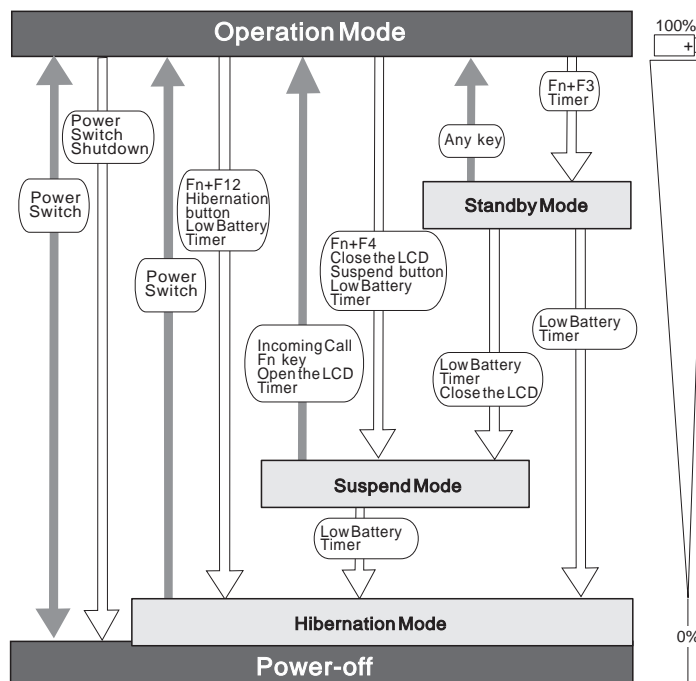

## *Saving Battery Power*

### **ATTENTION**

You should not enter suspend or hibernation mode when your computer is using the following applications:

- Playing or recording audio
- Playing a movie
- Playing a game
- Other multimedia application

Stop these applications before entering suspend or hibernation mode.

## Customizing Power Management

This section describes how to customize power management. Use the power management mode appropriate to your operation.

### *Setting the Screen Off Timer or the Suspend Timer*

To set the screen off timer or the suspend timer, do the following:



#### **For Windows 95:**

**1** Start the ThinkPad Configuration program.

**2** Click on the **Power Management** () button.

The "Power Properties" window appears.

**3** Select the **Power Mode** tab.

The "Power Mode" subwindow appears.

**4** Select **Customized**.



The bottom gray portion is displayed in black, and you can specify the timeout value in minutes in the **Screen off timer** box or **Suspend timer** box.

**5** Click on **OK**.

## *Saving Battery Power*



**For Windows NT, Windows 3.11, or OS/2:**

- 1** Start the ThinkPad Configuration program.
- 2** Click on the **Power Management** () button.  
Three buttons appear on the right.
- 3** Click on the **Power Mode Settings** () button.  
The “Power Mode Settings” window appears.
- 4** Specify the timeout value in minutes in the **Screen off timer** box or **Suspend timer** box.
- 5** Click on **OK**.

*Enabling Hibernation Mode*

To enable hibernation mode, do the following:





**For Windows 95:**

- 1** Start the ThinkPad Configuration program.
- 2** Click on the **Power Management** () button.  
The “Power Properties” window appears.
- 3** Select the **Hibernation** tab.  
The “Hibernation” subwindow appears.
- 4** Click on **Enable Hibernation**. (If you have already created a hibernation file, this button appears in gray and you cannot click on it.)  
The “Enable Hibernation” subwindow appears.
- 5** Click on **Create Now**.
- 6** Click on **Close**; then **OK**.



**For Windows NT, Windows 3.11, or OS/2:**

- 1** Start the ThinkPad Configuration program.
- 2** Click on the **Power Management** () button.
- 3** Click on the **Suspend/Resume Options** () button.  
The “Suspend/Resume Options” window appears.
- 4** Click on the **Enable Hibernation..** button.
- 5** Click on **OK**.

## Considerations When Using a Power Management Mode

When you use a power management mode, you need to consider a few points, especially if you are using the network.

### *Considerations for Suspend Mode*

Consider the following before using suspend mode:

The computer can enter suspend mode when used with the following operating systems:

- IBM PC-DOS Version 7.0
- IBM OS/2 Warp Version 4
- Microsoft Windows Version 3.11 with IBM PC-DOS Version 7.0
- Microsoft Windows 95
- Microsoft Windows NT 4.0

#### **Important**

If you use Windows Version 3.11, ensure that Advanced Power Management (APM) is installed according to the instructions in page 107.

Attached devices, such as a printer or serial device, stop running when the computer enters suspend mode. When you resume normal operation, the output might differ from what you expect, because the device might be reset or lose its configuration settings.

Sometimes you might want to use the computer with the LCD closed—for example, when an external monitor and keyboard are used. In such a case, turn on the computer with the LCD closed or enable **Will not suspend even if LCD is closed** option in **Suspend/Resume options** in **Power Management** of the ThinkPad Configuration program.

If the computer resumes normal operation by enabling **Resume on timer** or **Resume on incoming call** option in **Suspend/Resume options** in **Power Management** of the



## ***Saving Battery Power***

ThinkPad Configuration program, only a blank screen is displayed. To display a power-on password prompt, press any key or move your pointing device.

If the computer is powered with AC power and is using one of the following IBM PC Cards, it enters *standby mode*:

- IBM 3270 Emulation Credit Card Adapter
- IBM Token-Ring 16/4 Credit Card Adapter
- IBM Credit Card Adapter for Ethernet
- IBM 5250 Emulation Credit Card Adapter

If other PC Cards are used and the computer enters suspend mode, all application programs stop. Communication also stops for communication PC Cards not in the preceding list. For some PC Cards, power to the PC Cards might also turn off.

If the computer is powered with battery power, it turns power off to the PC Card, and communication stops for communication PC Cards, it stays in suspend mode longer.

If communication for a PC Card is not reestablished after normal operation resumes, remove and then reinstall the PC Card before restarting the system or application program. For other kinds of PC Cards, if the PC Card or computer does not operate, restart the application or computer.

If the computer is using one of the following IBM modem cards and detects an incoming call while in suspend mode, the computer automatically resumes normal operation:

- IBM 28.8/14.4 Data/FAX Modem
- IBM PCMCIA Data/FAX Modem
- IBM High Speed PCMCIA Data/FAX Modem
- IBM Microelectronics 2.4/9.6 Data/FAX Modem
- IBM Microelectronics 14.4/14.4 Data/FAX Modem

## ***Saving Battery Power***

- IBM Wireless Modem for ARDIS
- IBM Wireless Modem for Mobitex
- IBM Wireless Modem for Cellular/CDPD

While a communication link is active, the computer does not enter suspend mode.



### **Note:**

You must set the **Resume on incoming call** option in the ThinkPad Configuration program so the computer automatically resumes normal operation.

#### **For Windows 95:**

1. Click on the **Power Management** () button.
2. Click on the **Suspend/Resume options** tab.
3. Select the **Resume on incoming call** option.

#### **For Windows NT, Windows 3.11, or OS/2:**

1. Click on the **Power Management** () button.
2. Click on the **Suspend/Resume options** () button; then select the **Resume on incoming call** option.

**For DOS:** Enter PS2 RI E

## ***Considerations for Hibernation Mode***

Consider the following before using hibernation mode:

Hibernation mode might be terminated if you connect your computer to a port replicator or if you use a particular PC Card.

Do not run any tasks while the hibernation file is being created.

The computer uses battery power to enter hibernation mode. Therefore, it reserves some battery power if the **Hibernate when battery becomes low** option is enabled in **Suspend/Resume options** in **Power Management** of the ThinkPad Configuration program. This can cause the

## ***Saving Battery Power***

battery operating time to be shorter than the time publicly stated.

Do not remove memory when the computer is in hibernation mode. If you do, the computer resumes from hibernation mode without recognizing the changed memory size. To ensure that the computer recognizes the correct memory size, shut down; then restart your operating system.

If the computer is powered with battery power, it turns power off to the PC Card when entering hibernation mode. When resuming normal operation, if the PC Card or computer does not operate, restart the application or computer.

If the computer is powered with AC power, it does not enter hibernation mode if it is using one of the following IBM PC Cards:

- IBM 28.8/14.4 Data/FAX Modem
- IBM PCMCIA Data/FAX Modem
- IBM High Speed PCMCIA Data/FAX Modem
- IBM 3270 Emulation Credit Card Adapter
- IBM Token-Ring 16/4 Credit Card Adapter
- IBM Credit Card Adapter for Ethernet
- IBM 5250 Emulation Credit Card Adapter
- IBM Microelectronics 2.4/9.6 Data/FAX Modem
- IBM Microelectronics 14.4/14.4 Data/FAX Modem
- IBM Wireless Modem for ARDIS
- IBM Wireless Modem for Mobitex
- IBM Wireless Modem for Cellular/CDPD

This prevents possible problems from occurring with communication application programs after the computer returns to normal operation.

**Note:**

If the communication links are still not reestablished, remove and then reinstall the PC Card before restarting the system or application program.

## Saving Battery Power

### *Considerations When Installing or Reinstalling the Operating System*

When you install an operating system, install it with Advanced Power Management (APM). Also install the ThinkPad Configuration program with the Utility Diskette to use power management mode.

**Note:** To install the software, see the online book.



*If you are using Windows 95 or OS/2, APM is automatically installed in your computer.*



*If you are using DOS, APM is automatically installed in your computer. To verify that the computer has installed APM correctly, type `power` at the command prompt and press **Enter**. If a screen similar to the following appears, APM is successfully installed:*

```
Power Management Status
-----
Setting =  ADV: REG
CPU: idle 32% of time.

AC Line Status : OFFLINE

Battery status : High
```

*If not, add the following line to your CONFIG.SYS file, using a text editor such as the DOS editor:*

```
DEVICE=C:\DOS\POWER.EXE
```

## Saving Battery Power



If you are using Windows 3.11, follow these instructions to check and install APM for Windows:

**1** Start the computer.

Make sure that the current directory is Windows (usually C:\WINDOWS>).

**2** Type `SETUP` at the command prompt and press **Enter**.

The following appears:

```
Windows Setup
=====

If your computer or network appears on the Hardware Compatibility List
with an asterisk next to it, press F1 before continuing.

System Information
Computer:      MS-DOS System
Display:      MagicGraph128XD 8  x6  256 small font
Mouse:        Microsoft, or IBM PS/2
```

Does **MS-DOS System with APM** appear for the item **Computer**?

**Yes.**

APM is already installed. Press **F3** to exit the setup, and skip the remaining steps.

**No.**

Go on to the following step.

**3** Using the Arrow keys (**↑**, **↓**), position the highlighted cursor over **MS-DOS System** and press **Enter**.

**4** Position the highlighted cursor over **MS-DOS System with APM** and press **Enter**.

**5** Verify that the item **Computer** has changed to **MS-DOS System with APM** on the screen. If not, return to step 3.

## Saving Battery Power

```
Windows Setup
=====

If your computer or network appears on the Hardware Compatibility List
with an asterisk next to it, press F1 before continuing.

System Information
Computer:      MS-DOS System with APM
Display:      MagicGraph128XD 8  x6  256 small font
Mouse:        Microsoft, or IBM PS/2
```

**6** Press **Enter** to install APM.

**7** Restart the system to make APM effective.

## Using Other Battery-Saving Methods

Another battery-saving method is to decrease the LCD brightness. You can use the ThinkPad Configuration program to decrease the brightness of the LCD by clicking on the **LCD** () button and selecting **Normal** for **Brightness (battery operation)** in the window that appears.

You can also decrease the LCD brightness to conserve battery power by adjusting the brightness control on the LCD to the lowest level possible that allows you to comfortably view the screen.

## Replacing the Battery Pack

To replace the battery pack, do as follows:

- 1** Power off your computer.
- 2** Close the LCD and turn the computer over.
- 3** Pull the battery-pack lock upward **1** ; and slide it toward the rear of the computer **2** .

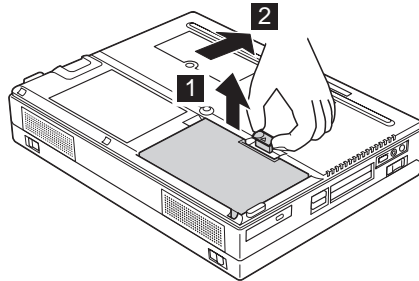

- 4** Using the notch **3** beside the battery pack, lift the battery pack **4** from the computer.

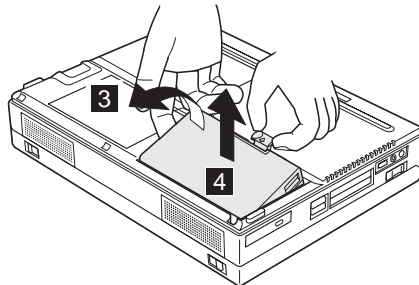

## Replacing the Battery Pack

- 5 Install a fully charged spare battery pack as shown 5 , sliding the battery-pack lock toward the rear of the computer 6 .

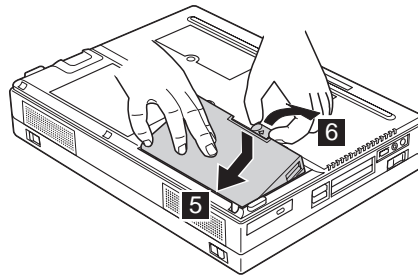

- 6 Push the battery-pack lock downward 7 .

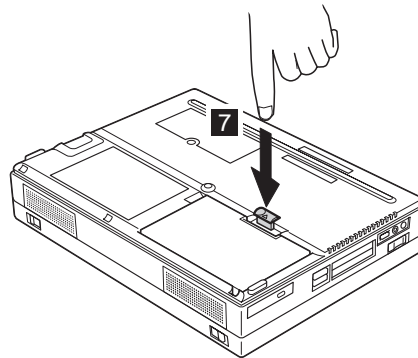

- 7 Turn the computer over again; then open the LCD.  
You have finished replacing the battery pack.

**Note:** You can replace the battery when the computer is in hibernation mode. (You cannot replace in when the computer is in suspend mode.) If you are using a PC Card, however, the computer might not be able to enter hibernation mode. If this happens, power off the computer.



## Chapter 4. Protecting Your Computer

---

This chapter provides information about how to protect your computer from theft or unauthorized use. It also describes how to display your personal information, such as your name or address, on the password prompt screen.

Using Passwords . . . . .	112
Entering a Password . . . . .	112
Setting a Password . . . . .	113
Changing or Removing a Password . . . . .	117
For a Power-On Password or HDD Password . . . . .	117
For a Supervisor Password . . . . .	119
Using the Personalization Editor . . . . .	123
Using Locks . . . . .	127

## Using Passwords

The password-setting feature prevents your computer from being used by others. Once you set a password, a prompt appears on the screen each time you turn on the computer. You must enter your password at the prompt. You will not be able to use the computer unless you type the correct password. You can set the following passwords on your computer:

The **power-on password** protects your computer from being used by unauthorized persons.

The **hard disk password** protects the data on your hard disk from being accessed by unauthorized persons.

The **supervisor password** protects the system information stored in Easy-Setup and also makes your computer tamper-resistant.

## Entering a Password

Once you set a password, a password prompt appears at the top left corner of the screen. This prompt appears each time you turn on your computer or when your computer returns from suspend mode to normal operation.

However, a password prompt is not displayed if the computer returns to normal operation by a preset timer or an incoming call on the modem, in which case you will have to display it by pressing a key or moving the pointing device.

To enter a password, do the following:

**1** Type your password.

The  symbol appears each time you press a key. Don't hold down a key too long, since the same character will be entered continuously.

**2** Press the **Enter** key.

## *Using Passwords*

An **OK** appears if you enter the correct password, and an **X** appears if you enter the wrong password. If you fail to enter the correct password in three tries, you must turn off the computer, wait 5 seconds, and then turn it on again and retry.

## Setting a Password

### Do Not Forget Your Password

If you forget your hard disk or supervisor password, there is **no way to reset your password or recover data from the hard disk**. You have to take your computer to an IBM authorized reseller or an IBM marketing representative to have the hard disk or the system board replaced. Proof of purchase is required, and an additional charge might be required for the service. Neither an IBM authorized reseller nor IBM marketing representative can make the hard disk drive usable.

To set a password, do the following:

- 1** Start Easy-Setup.
  - a)** Press and hold **F1**; then turn on the computer.
  - b)** Hold **F1** until the “Easy-Setup” menu appears.

## Using Passwords

- Click on **Password** in the “Easy-Setup” menu. The “Password” submenu appears:

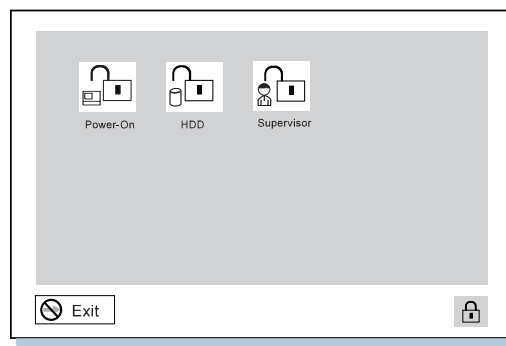

Selecting this icon displays a submenu for setting the **power-on** password.



Selecting this icon displays a submenu for setting the **hard disk drive (HDD)** password.



Selecting this icon displays a submenu for setting the **supervisor** password.

**Note:** An unlocked keylock icon indicates a password that is not yet set.

- Click on the type of password you want to set:  
**Power-On**, **HDD**, or **Supervisor**.

## Using Passwords

**4** Type your desired appropriate password.



**Note:** You can type a maximum of 7 random characters using a combination of letters (A to Z) and numbers (0 to 9). Uppercase and lowercase letters (for example, A and a) are treated as the same characters.

If you type a wrong character, use the **Backspace** key to erase it and then type the correct one.

**5** Press **Enter**. The “Password Confirmation” submenu appears:

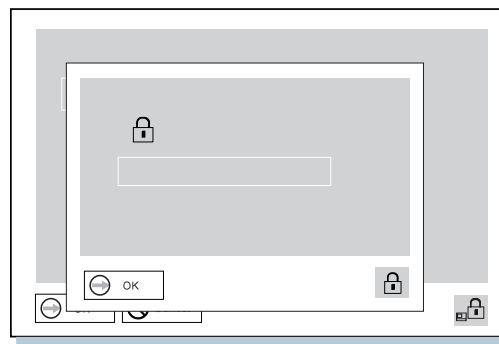

## Using Passwords

- 6 Type your password again to verify it; then press **Enter** again.

**Note:** The following submenu appears if you are setting the hard disk or the supervisor password, reminding you to write down the password on a piece of paper and to keep it in a safe place.

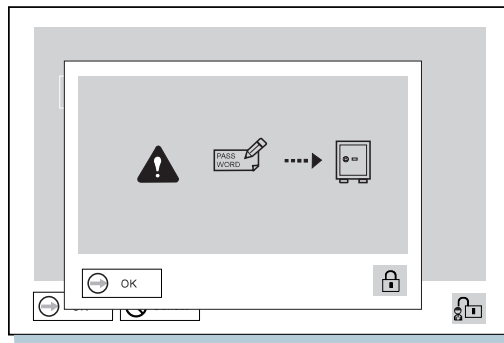

Your password is set.

## Changing or Removing a Password

Security features in this procedure prevent someone from removing a password and using your computer. To change or remove a password, do the following:

*For a Power-On Password or HDD Password*

- 1** Turn off the computer and wait at least 5 seconds; then turn on the computer.

The password prompt appears.

To change the password, go to the next step.

To remove the password, go to step 5 on page 118.

- 2** Type your current password and press the **Spacebar**.

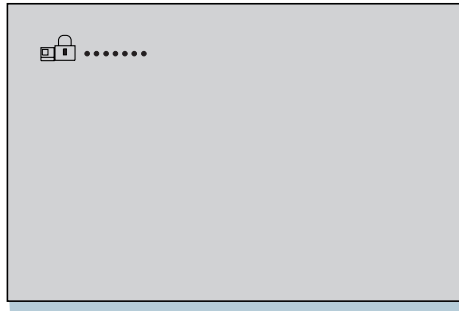

- 3** To change the password, type the new password; then press the **Spacebar**.

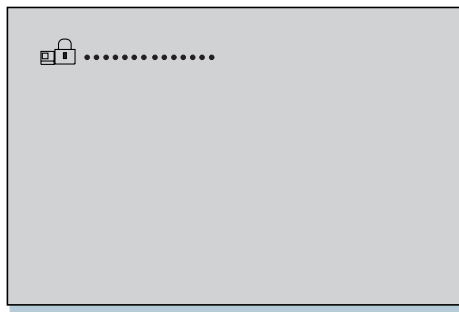

## Using Passwords

- 4 Type the new password again to verify it; then press **Enter**.

The following submenu appears and system starts.

**Note:** Write down the password on a piece of paper and keep it in a safe place.

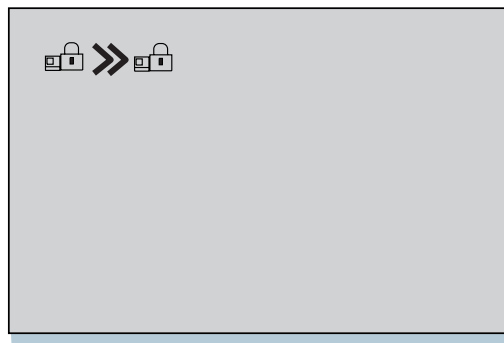

You have changed your password. Skip the remaining steps.

- 5 Type your current password and press the **Spacebar**.

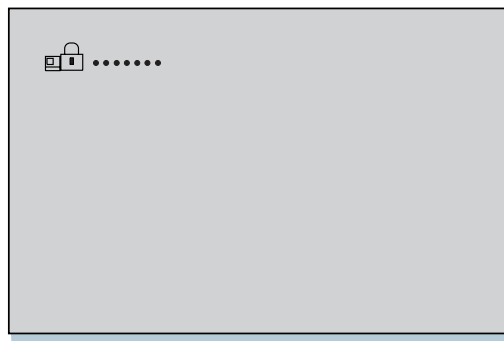



## Using Passwords

### 6 Press **Enter**.

The following submenu appears and system starts.



You have removed your password.

### *For a Supervisor Password*

#### 1 Start Easy-Setup.

**a)** Press and hold **F1**; then turn on the computer.

**b)** Hold **F1** until the password prompt appears.

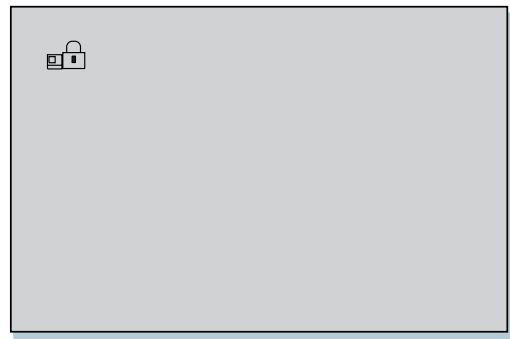

#### 2 Enter the supervisor password.

The “Easy-Setup” menu appears.

#### 3 Select **Password** on the menu.

## Using Passwords

### 4 Select **Supervisor**.

To change the password, go to the next step.  
To remove the password, go to step 10 on page 121.

### 5 Enter the current password and press the **Spacebar**.



### 6 Type the new password; then press the **Enter**.

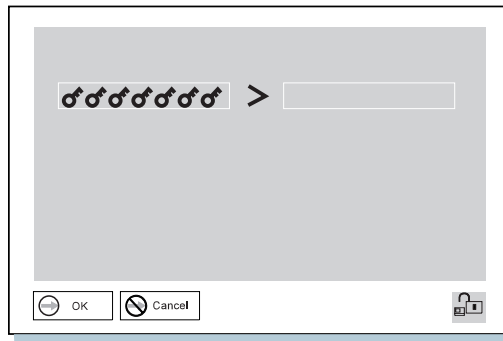

## Using Passwords

- 7 Type the new password again to verify it; then press **Enter**.

**Note:** The following submenu appears and reminding you to write down the password on a piece of paper and keep it in a safe place.

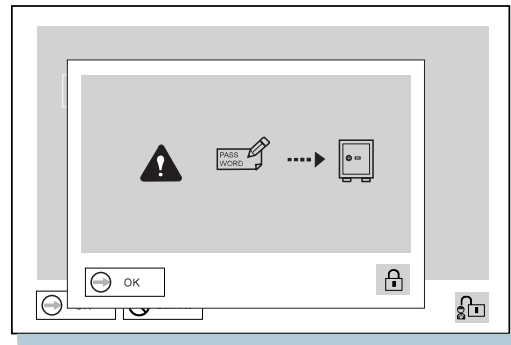

- 8 Press **Enter** again.

- 9 Click on **Exit**; then **Restart**.

The supervisor password has been changed. Your computer restarts. Skip the remaining steps.

- 10 Enter the current password and press the **Spacebar**.

- 11 Press **Enter** twice.

- 12 Click on **Exit**.

- 13 Select **Restart**.

The supervisor password has been removed. Your computer restarts.

## Using Passwords

### Removing a Password with Supervisor Authority

You can remove a power-on password (even if you don't know it) if you know the supervisor password.

1. Power on the computer by pressing **F1**.

The password prompt appears.

2. Enter the supervisor password. The “Easy-Setup” menu appears.

3. Select **Password** on the menu.

4. Select **Power on** on the menu.

5. Type the supervisor password; then press **Spacebar**.

6. Press **Enter**. The “Password Confirmation” submenu appears:

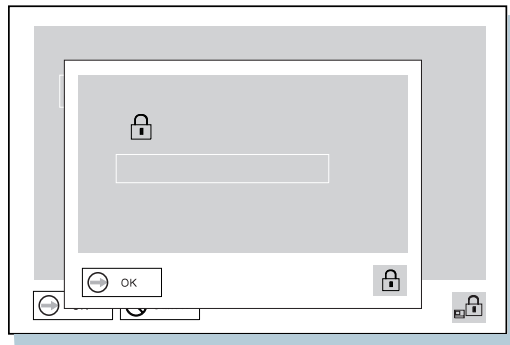

7. Press **Enter** again.

8. Click on **Exit**; then select **Restart**. Your computer restarts. The power-on password has been removed.

## Using the Personalization Editor

With the Personalization Editor, you can display such personal information as your name and address on the screen each time you power on your computer. This feature helps you to identify your computer when identical computers are being used in your location, or to deter theft.

A personalized password-prompt screen consists of two parts: the *personal data area* 1 and the *background bitmap area* 2 .

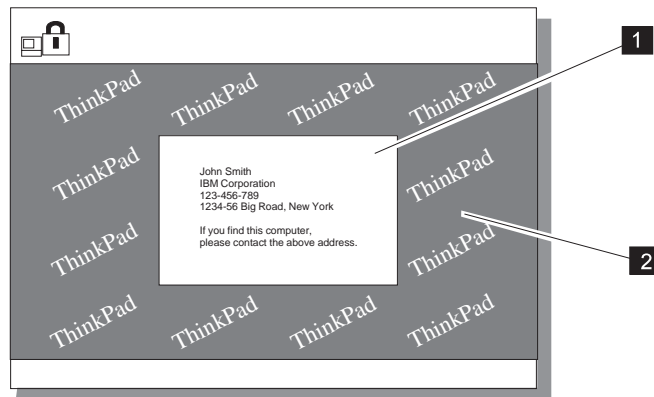

## Using the Personalization Editor

To register your name, address, and company on the Personalization Editor, do the following:

**Note:** To display this information, the power-on password must already have been set.

- 1** Turn on the computer.
- 2** Make a backup copy of the DOS, Personalization Utility Diskette using your operating system's diskcopy command.
- 3** Insert the backup copy of the DOS, Personalization Utility Diskette into the diskette drive.
- 4** Open the **Personalization Editor**.
  - a)** Click on **Start**.
  - b)** Move the cursor to **Programs, ThinkPad**; then click on **Personalization Editor**.

The following window appears:

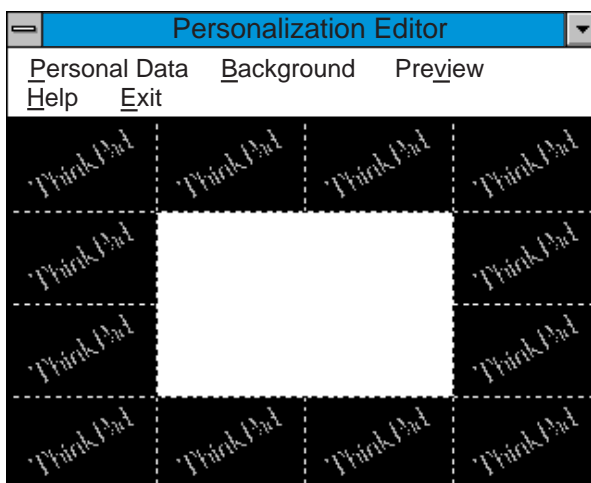

## Using the Personalization Editor

- 5** Click on **Personal Data** and type in the necessary information into the boxes.

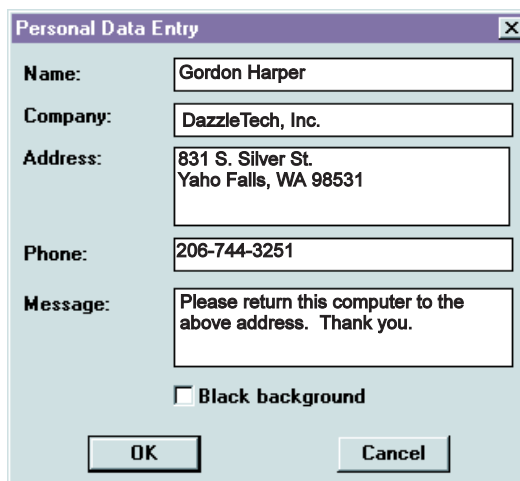

The screenshot shows a dialog box titled "Personal Data Entry" with a close button (X) in the top right corner. The dialog contains several text input fields and a checkbox. The fields are labeled as follows:

- Name:** Gordon Harper
- Company:** DazzleTech, Inc.
- Address:** 831 S. Silver St.  
Yaho Falls, WA 98531
- Phone:** 206-744-3251
- Message:** Please return this computer to the above address. Thank you.

Below the message field is a checkbox labeled "Black background" which is currently unchecked. At the bottom of the dialog are two buttons: "OK" and "Cancel".

If you want to create the background bitmap, do as follows; otherwise, go to step 10 on page 126.

- 6** Select **Background** in the "Personalization Editor" window.
- Windows Paint automatically opens.
- 7** Draw an image or color the background.
- Your bitmap size must be 160 by 100 pels. To change the size, click on **Image** and then **Attributes**. Specify a **Width** of 160, **Height** of 100, and set **Unit** to pels.
- 8** Select **File** and save **Save As** to save and name your drawing as a 16-color bitmap file on the backup copy of the DOS, Personalization Utility Diskette.

**Note:** To preview the actual full-size of the screen, select **Preview**.

- 9** Press **Enter** to return to the previous window.

## Using the Personalization Editor

- 10** Turn off the computer.
- 11** Insert the backup copy of the DOS, Personalization Utility Diskette into the diskette drive; then turn on the computer.
- 12** Select **Update personalization data** at the menu window; then follow the instructions in the window.  
  
Your data is copied from DOS, Personalization Utility Diskette and stored in the nonvolatile memory in the computer.
- 13** After the data is stored, turn off the computer.
- 14** Set your password if you have not set yet.  
  
Click on **Help** for more information.

The information that you typed is displayed the next time you power on.

### Delete a Personalization Screen

To delete a personalization screen from the password-prompt screen, as follows:

- 1.** Turn off the computer.
- 2.** Insert the backup copy of the DOS, Personalization Utility Diskette into the diskette drive; then turn on the computer.
- 3.** Select **Delete personalization data** from the menu; then follow the instructions on the screen.
- 4.** After the data is updated, restart the computer.



## Using Locks

You can attach a mechanical lock to your computer, to prevent it from being removed without your permission.

To attach a lock, do the following:

Attach a mechanical lock to the keyhole **1** on the side of the computer; then secure the chain on the lock to a secure stationary object.

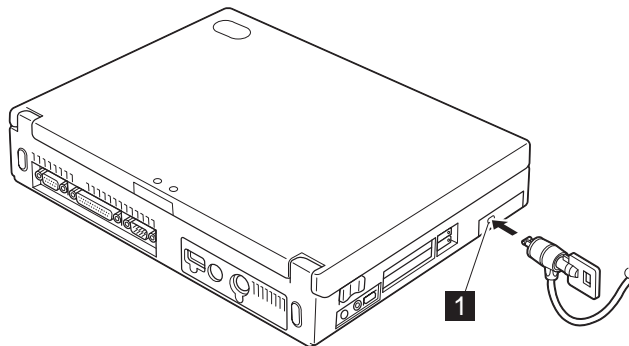

**Note:** You are responsible for evaluating, selecting, and implementing the locking devices and security features. IBM makes no comments, judgments, or warranties about the function, quality, or performance of locking devices and security features.

## *Using Locks*

## Chapter 5. Solving Computer Problems

---

Frequently Asked Questions . . . . .	130
Hints, Tips, and Limitations . . . . .	135
Troubleshooting Guide . . . . .	136
Troubleshooting Charts . . . . .	137
Error Codes or Screen Messages . . . . .	138
No Error Codes or Screen Messages . . . . .	142
Input Problems . . . . .	143
Suspend or Hibernation Problems . . . . .	144
LCD Problems . . . . .	147
An Indicator Problem . . . . .	148
Battery Problems . . . . .	148
CD-ROM Drive Problems . . . . .	149
Infrared Communication Problems . . . . .	150
A Universal Serial Bus (USB) Problem . . . . .	151
PC Card Problems . . . . .	151
A Printer Problem . . . . .	155
External Monitor Problems . . . . .	155
Port Replicator Problems . . . . .	157
Other Option Problems . . . . .	159
Software Problems . . . . .	161
Other Problems . . . . .	162
Testing Your Computer . . . . .	163
Recovering Lost or Damaged Software . . . . .	165
Using the Diskette Factory . . . . .	165
Using the Recovery CD (Windows 95 Only) . . . . .	167

## Frequently Asked Questions

### How to Start the ThinkPad Configuration Program

To start the ThinkPad Configuration program;

- 1 Click on **Start**.
- 2 Move the cursor on **Programs, ThinkPad**; then click on **ThinkPad Configuration**.

ThinkPad Configuration program window appears:

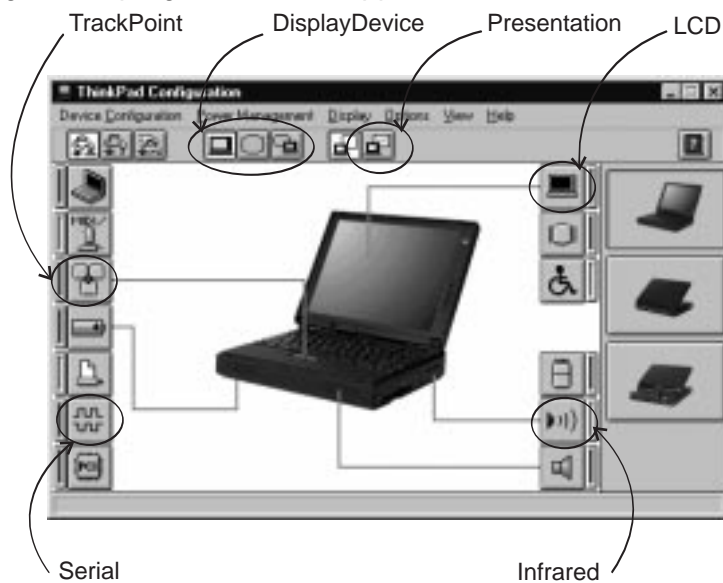

**Note:** You can open the ThinkPad Configuration program by clicking on the lower right part of the screen on the Windows 95 taskbar in the system tray.

### My screen keeps blanking when I do not want it to. How do I stop this?

You can disable any system timers, such as the LCD turn-off timer or the power management mode timers with the ThinkPad Configuration program.

- 1 Start the ThinkPad Configuration program.
- 2 Click on the **Disable Screen Blanking** button.

### **How do I use my infrared port as a communications port?**

Your ThinkPad's infrared port may be disabled in order to free resources for another communications device such as the serial port. If it is disabled, you need to enable it before you use it. To check and enable your infrared port, do as follows:

- 1** Start the ThinkPad Configuration program.
- 2** Click on the **Infrared** button.
- 3** Click on **Enable**.

A "Warning" window might appear and show the message that the hardware resource is in use by another communications device.

- 4** Click on **Disable Device**.

A "Warning" window will prompt you to restart your computer.

- 5** Click on **OK**; then the computer restarts.

Be sure to save work and quit other programs before you restart your computer.

**Note:** If you check your infrared port and it is already enabled, you should be able to use it immediately without changing any settings.

After your infrared port is enabled, you should be able to use it as a communications port. If it does not work properly, you might have a problem with the communication software application on your system or the device that you are trying to communicate with. Check the on-line help system for your communications software other device appear to be working properly.

### **How do I use my serial port as a communications port?**

Your ThinkPad's serial port might be disabled in order to free resources for another communications device such as the infrared port. If it is disabled, you need to enable it before you use it. To check and enable your serial port, do as follows:

- 1** Start the ThinkPad Configuration program.
- 2** Click on the **Serial Port** button.
- 3** Click on **Enable**.

A "Warning" window might appear and show the message that the hardware resource is in used by another communications device.

- 4** Click on **Disable Device**.

## Frequently Asked Questions

A “Warning” window will prompt you to restart your computer.

- 5 Click on **OK**; then the computer restart.

Be sure to save work and quit other programs before you restart your computer.

**Note:** If you check your serial port and it is already enabled, you should be able to use it immediately without changing any settings.

After your serial port is enabled, you should be able to use it as a communications port. If it does not work properly, you might have a problem with the communications software application or the cable or device attached to the serial port. Check the on-line help system for your communications software if the cable and attached device appear to be working properly.

### How do I use an external mouse when I am at my desk, but then use the TrackPoint when I am away from my desk?

The TrackPoint has an “auto/disable” setting that will disable the TrackPoint when you power on or reboot the computer with an external mouse is attached. When you want to enable the TrackPoint, remove the external mouse; then reboot the computer.

**Note:** You can set up the TrackPoint manually with ThinkPad Configuration program as follows:

- 1 Start the ThinkPad Configuration program.
- 2 Click on the **TrackPoint** button.
- 3 Select **Enable**, **Disable**, or **Auto/Disable**.
- 4 Click on **OK**.

### Why can I not get the highest possible resolution out of my external monitor when I am using the LCD and external monitor at the same time?

You can set any resolution for both of the ThinkPad LCD and the external monitor. At the same time, the resolution of them is always the same. If you set the higher resolution for the ThinkPad LCD, you can see a part of the screen on it. Other parts can be seen by moving the screen with the TrackPoint or other pointing device. You can change the display output type to the LCD, external monitor, or both with **Display Device** buttons of the ThinkPad Configuration program or **Fn+F7**.

You can set up the external display as follows:

## *Frequently Asked Questions*

- 1** Double-click on **My Computer, Control Panel**; then **Display**.
- 2** Click on the **Properties...** button.  
“Display Properties” window appears.
- 3** Click on the **Settings** tab.
- 4** Click on **Advanced Properties**.
- 5** Click on **Monitor**.
- 6** Click on the **Change** button.
- 7** Select **Show All Devices**.
- 8** Select Manufactures and Models in the next window.
- 9** Click on **OK**; then **Close**.
- 10** Set **Color palette** and **Desktop area** in the “Display Properties” windows.
- 11** Click on **OK**.

**How can I set up the external monitor if the Windows Plug and Play feature does not detect it?**

Do as follows:

- 1** Double-click on **My Computer, Control Panel**; then **Display**.
- 2** Click on the **Properties...** button.  
“Display Properties” window appears.
- 3** Click on the **Settings** tab.
- 4** Click on the **Advanced Properties**.
- 5** Click on **Monitor**.
- 6** Make sure **Automatically Detect Plug and Play monitors** is checked.
- 7** If the option is checked and your monitor is still not recognized after rebooting, then click the **Change** button.
- 8** Select the monitor type that you have attached and then click on **OK**.
- 9** Click on **Close**.
- 10** If you are prompted to restart your computer, click on **OK**.

## ***Frequently Asked Questions***

### **How do I maximize battery life?**

To maximize battery life, be sure to do the following:

When you need maximum battery life;

- Use the battery until the charge is completely depleted (until battery and power LEDs flash in unison).
- Recharge completely before using (battery is fully charged when the AC adapter is in plugged in and the battery LED is green).

For a new battery or a battery that you have not used recently;

- Use the battery until the charge is completely depleted (until battery and power LEDs flash in unison).
- Recharge completely before using (battery is fully charged when the AC adapter is plugged in and the battery LED is green).
- Repeat these steps three times.

Always use power management features such as Advanced Power Management (APM), Power Modes, Standby, Suspend, and Hibernation. See the “Using the Power Management Modes” on page 93 for more detailed information about power management features.

### **How do I load a different operating system on this machine?**

–Or–

### **Where do I get ThinkPad device drivers for this operating system?**

See the **online book** for installing a new operating system and device drivers. You can get the ThinkPad device drivers by using the Diskette Factory. Before installing an new operating system, always be sure to:

Print all of the installing software section of the **online book**.

Make backup diskettes of the device drivers and applications for your new operating system with Diskette Factory. See “Using the Diskette Factory” on page 165.

Be sure to make a DOS system diskette that has the DOS FDISK.EXE and FORMAT.EXE utilities and the CD-ROM device driver for DOS.

### **How do I use Recovery CD to reload my factory installed ThinkPad operating system and applications?**

See “Using the Recovery CD (Windows 95 Only)” on page 167.



## Hints, Tips, and Limitations

This section describes hints, tips, and limitations.



### **For Windows 95:**

When the system cannot enter suspend mode due to on-going activities, the Intel USB camera attached to the system is disabled. To reenale the USB camera, unplug it and plug it in again.



### **For OS/2 Warp:**

When you have formatted the drive in HPFS that has more than 64 MB of memory, hibernation is not supported.

If the COM port does not work even if you have set it up correctly with the ThinkPad Configuration program, do as follows:

1. Open **System Setup**.
2. Select **Hardware Manager**.
3. Select a folder from the menu.
4. Select **Properties**.
5. Under the default pull-down menu, select **No Hardware Detection**. If it has already been selected, change the setting.
6. Open the ThinkPad Configuration program.
7. Set the COM port as desired.
8. Reboot the system.



### **For Windows NT:**

For Windows NT 4.0, hibernation is not supported when the drive is formatted by NTFS.

## Troubleshooting Guide

The following chart shows how to find or solve a problem.

### If a beep sounds, if a message appears, or if a function-related problem occurs:

- 1** Find your symptom from the table and try solving the problem. → “Troubleshooting Charts” on page 137
- 2** If you can't solve the problem, run the test and make sure the hardware and the device drivers are OK. → “Testing Your Computer” on page 163
- 3** Note the error code and have the computer serviced. → Chapter 6

### If you accidentally lose or damage software in your computer:

- Recover it by using the Recovery CD or the Diskette Factory. → “Recovering Lost or Damaged Software” on page 165

## Troubleshooting Charts

If your computer has an error, it typically displays a message or an error code, or a beep sounds when you power it on. Go through the charts and look for your problem. If you find the problem, go to the page indicated and do the specified action.

<b>Troubleshooting Chart</b>	<b>Page</b>
Error codes or screen messages	138
No error codes or screen messages	142
Input problems	143
Suspend or hibernation problems	144
LCD problems	147
An indicator problem	148
Battery problems	148
CD-ROM drive problems	149
Infrared communication problems	150
A universal serial bus (USB) problem	151
PC Card problems	151
A printer problem	155
External monitor problems	155
Port replicator problems	157
Other option problems	159
Software problems	161
Other problems	162

## Troubleshooting Charts

### Error Codes or Screen Messages



**Note:** In the charts, x can be any character.

Message	Action
<p>⌈9990301 ⌈9990302 ⌈9990305</p> <p>(Incorrect connection of the hard disk drive might cause these error codes to appear.)</p>	<p>Your computer can't find the startup drive. Do the following:</p> <ol style="list-style-type: none"><li>1. Turn off the computer.</li><li>2. Press and hold <b>F1</b>; then turn on the computer to start Easy-Setup. Hold <b>F1</b> until the Easy-Setup menu appears.</li><li>3. Select the <b>Start up</b> icon. If you are unable to set the startup sequence, have the computer serviced.</li><li>4. Check the devices in the startup sequence box. Is the default drive listed in the startup sequence box? <b>Yes</b> Exit this window, and turn off the computer. <b>No</b> Select the <b>Reset</b> icon.</li><li>5. Is an operating system installed? <b>Yes</b> Go to step 7. <b>No</b> Install the operating system in your computer.</li><li>6. After you install the operating system, turn off the computer.</li><li>7. Turn on the computer.</li></ol> <p>If the same message appears, have the computer serviced.</p>
<p>⌈99xxxxx (except the above ⌈999030x errors)</p>	<p>Have the computer serviced.</p>
<p>16x or 17x (undefined date or configuration error)</p>	<p>Follow the instructions on the screen.</p>
<p>174 (device configuration error)</p>	<p>Have the computer serviced.</p>
<p>184 (invalid password error)</p>	<p>The password entered is invalid.</p> <p>Turn off the computer and wait at least 5 seconds; then turn it on again and type the correct password.</p>
<p>190 (critically low-battery error)</p>	<p>The computer turned off, because the battery is low.</p> <p>Connect the AC Adapter to the computer and charge the battery pack, or replace the battery pack with a fully charged one.</p>

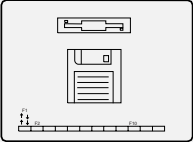

## Troubleshooting Charts

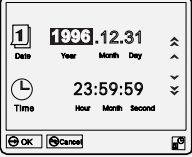
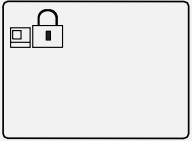
Message	Action
195 (hibernation error)	<p>The system configuration differs between the time your computer entered hibernation mode and the time it exited this mode, and your computer cannot resume normal operation.</p> <p style="padding-left: 40px;">Change the system configuration to what it was before your computer entered hibernation mode. If the memory size was changed, re-create the hibernation file.</p>
196 (hibernation error)	<p>The computer cannot read the hibernation file.</p> <p>Have the computer serviced.</p>
2xx (memory error)	<p>Make sure that the DIMM option is correctly installed.</p>
30x (keyboard error)	<p>Make sure that no object is placed on the keyboard or on the external keyboard, if you have one. Power off the computer and power off all attached devices. Power on the computer first; then power on the attached devices.</p> <p>If you still have a problem, do the following:</p> <p style="padding-left: 40px;">If an external keyboard is connected, do the following:</p> <ul style="list-style-type: none"> <li>– Turn off the computer and disconnect the external keyboard; then turn on the computer. Make sure that your keyboard operation is correct. If it is, have the external keyboard serviced.</li> <li>– Make sure that the external keyboard is connected to the correct connector.</li> </ul> <p>Test the computer by selecting the <b>Start</b> icon in the Easy-Setup “Test” submenu.</p> <ul style="list-style-type: none"> <li>– If the computer stops during the test, have the computer serviced.</li> </ul>
<p><b>Diskette and F1 prompts</b></p> 	<p>Make sure that the self-starting diskette is inserted correctly (with the label facing up and metal-shutter end first) in the diskette drive.</p> <p>If it is, press <b>F1</b>. If both prompts remain, have the computer serviced.</p>

## Troubleshooting Charts

Message	Action
<p>A 163 error appears and then the <i>Date and Time</i> window appears.</p> 	<p>Neither the date nor the time is set in the computer.</p> <p>Set the date and time by typing or clicking on ▲ or ▼ to set the values; then click on <b>OK</b>.</p> <p>When both the power-on password and supervisor password are set, do the following:</p> <ol style="list-style-type: none"> <li>1. Power on the computer. The password prompt appears after the error code.</li> <li>2. Type the supervisor password, not the power-on password. An error window appears.</li> <li>3. Click on <b>OK</b> or press <b>Enter</b>.</li> <li>4. Set the time and date in the next screen; then press <b>Enter</b>. The system reboots.</li> </ol> <p><b>Note:</b> If the power-on password is rejected, reset the power-on password using Easy-Setup if you need to.</p>
<p>The power-on password prompt</p> 	<p>A power-on password or supervisor password is set. Type the correct password and press <b>Enter</b> to use the computer (see page 113).</p> <p>If the power-on password is not accepted, a supervisor password might have been set. Type the supervisor password and press <b>Enter</b>.</p> <p>If you still have a problem, have the computer serviced.</p>
<p>The hard disk password prompt</p> 	<p>A hard disk password is set. Type the correct password and press <b>Enter</b> to use the computer (see page 113).</p> <p>If you still have a problem, have the computer serviced.</p>
<p>The “Test” submenu</p> 	<p>Select the <b>Start</b> icon and follow the instructions to test your system.</p> <p>If you cannot complete the test, have the computer serviced.</p> <p>If the test does not find the problem, but the problem persists nonetheless, go through the Troubleshooting Charts one by one.</p> <p>If the test ends in an error, note the error code and have the computer serviced.</p>

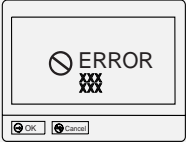
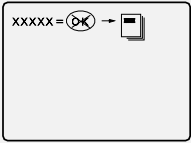
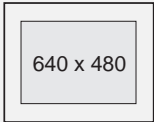
## Troubleshooting Charts

Message	Action
<p>A POST error prompt</p> 	<p>An error was found during POST. Press <b>Enter</b>; then select <b>Start</b> from the “Test” submenu and run the test.</p> <p>If the test ends in an error, note the error code and have the computer serviced.</p>
<p>An error prompt</p> 	<p>Turn off the computer and start Easy-Setup; then select <b>Test</b> to test the computer.</p> <p>If the test ends in an error, note the error code and have the computer serviced.</p> <p>You can start the operating system by pressing <b>F1</b> instead, and ignore the error.</p>
<p>The DOS full-screen looks smaller.</p> 	<p>When you use a DOS application that supports only the 640x480 resolution (VGA mode), the screen image might look slightly distorted or might appear smaller than the display size. This is to maintain compatibility with the other DOS applications. To expand the screen image to the same size as the actual screen, start the ThinkPad Configuration program and click on <b>LCD</b> (); then select the <b>Screen expansion</b> function. (The image may still look slightly distorted.)</p> <p><b>Note:</b> You can use the <b>Fn+F8</b> keys to do the same thing.</p>
<p>A panel or message that is not listed.</p>	<p>Turn off the computer and start Easy-Setup; then select <b>Test</b> to test the computer.</p> <p>If the test ends in an error, note the error code and have the computer serviced.</p> <p>If you cannot start Easy-Setup, have the computer serviced.</p>
<p>xxxxx <b>KB OK</b> appears and the computer stops.</p>	<p>Have the computer serviced.</p>

## Troubleshooting Charts

### No Error Codes or Screen Messages

Problem	Action
The screen is blank and you don't hear any beeps. <b>Note:</b> If you are not sure whether you heard any beeps, turn the computer off; then turn it on again, and listen again.	Make sure that: <ul style="list-style-type: none"><li>The battery pack is installed correctly.</li><li>The AC Adapter is connected to the computer and the power cord is plugged into a working electrical outlet.</li><li>The computer power is on. (Turn on the power switch again for confirmation.)</li></ul> If these items are correct and the screen remains blank, have the computer serviced.
The screen is blank and you can't hear any beeps. <b>Note:</b> If you are using an external display, go to "External Monitor Problems" on page 155.	If a power-on password is set, press any key to display the power-on password prompt, and then type the correct password and press <b>Enter</b> (see page 113). If the power-on password does not appear, the brightness control lever might be set to minimum brightness. Adjust the brightness level. If the screen still remains blank, have the computer serviced.
The screen is blank and you hear a continuous beep, or two or more beeps.	Have the computer serviced.
Only the cursor appears.	Reinstall your operating system and turn on the computer. If you still have a problem, have the computer serviced.



## Input Problems

Problem	Action
The pointer does not move after the computer awakens from one of the power management modes.	Make sure you followed the instructions in the online book correctly when you installed Windows with the Advanced Power Management (APM) option.
All or some keys on the keyboard do not work.	<p>If the problem occurred immediately after the computer returned from suspend mode, enter the power-on password if it is set.</p> <p>If an external keyboard is connected, the numeric keypad on your computer will not work. This is not a defect.</p> <p>If an external numeric keypad or a mouse is connected:</p> <ol style="list-style-type: none"> <li>1. Turn off the computer.</li> <li>2. Remove the external numeric keypad or the mouse.</li> <li>3. Turn on the computer and try using the keyboard again.</li> </ol> <p>If the keyboard problem is resolved, check the connection of the external numeric keypad, external keyboard, or mouse.</p> <p>If you still have a problem, have the computer serviced.</p>
The pointer drifts when the computer is turned on or after it resumes normal operation.	<p>The pointer may drift when you are not using the TrackPoint III during normal operation. This is a normal characteristic of the TrackPoint III and is not a defect. Pointer drifting may occur for several seconds under the following conditions:</p> <ul style="list-style-type: none"> <li>When the computer is turned on.</li> <li>When the computer resumes normal operation.</li> <li>When the TrackPoint III is pressed for a long time.</li> <li>When the temperature changes.</li> </ul>
The mouse or pointing device does not work.	<p>Make sure that the mouse or pointing-device cable is securely connected to the computer.</p> <p>Try using the TrackPoint III. If the TrackPoint III works, the error might be due to the mouse.</p> <p>If your mouse is incompatible with the IBM PS/2 mouse, disable the TrackPoint III using the ThinkPad Configuration program.</p> <p><b>Note:</b> See the manual supplied with the mouse for more information.</p>
The mouse buttons don't work.	Change the mouse driver to <b>Standard PS/2 Port Mouse</b> , and then change to <b>PS/2 TrackPoint III</b> .
A number appears when you type a letter.	The numeric lock function is on. To disable it, press and hold <b>Shift</b> ; then press <b>NumLk</b> .



## Troubleshooting Charts

Problem	Action
All or some keys on the external numeric keypad do not work.	Make sure that the external numeric keypad is correctly connected to the computer.
All or some keys on the external keyboard do not work.	<p>To use an external keyboard, you need to attach the keyboard/mouse connector to the computer. Make sure that:</p> <ul style="list-style-type: none"> <li>The keyboard/mouse connector is correctly connected to the computer.</li> <li>The keyboard connector is connected to the correct side of the keyboard/mouse connector.</li> </ul> <p>If these items are correct, disconnect the keyboard/mouse connector from the computer and make sure that the operation of the system keyboard is correct. If the system keyboard works, have the keyboard/mouse connector or the external keyboard serviced.</p>



## Suspend or Hibernation Problems

Problem	Action
The computer enters suspend mode automatically.	The computer enters suspend mode automatically when the processor temperature reaches a certain level. This is not a defect.
The computer enters suspend mode immediately after POST (the suspend lamp turns on).	<p>Make sure that:</p> <ul style="list-style-type: none"> <li>The battery pack is charged.</li> <li>The operating temperature is within the acceptable range. Refer to Appendix A.</li> </ul> <p>If these items are correct, have the computer serviced.</p>
Error 19 appears and the computer immediately turns off.	The battery pack power is getting low. Connect the AC Adapter to the computer, or replace the battery pack with a fully charged one.
The computer does not return from suspend mode, or the suspend lamp stays on and the computer does not work.	<p>The computer automatically enters suspend or hibernation mode when the battery power is empty. Do one of the following:</p> <ul style="list-style-type: none"> <li>Replace the battery pack with a fully charged one and then press <b>Fn</b>.</li> <li>Connect the AC Adapter to the computer; then press <b>Fn</b>.</li> </ul>

## Troubleshooting Charts

Problem	Action
<p>The LCD is blank after resuming.</p>	<p>Check if an external display was not connected before entering suspend mode. <b>Do not disconnect the external display while the computer is in suspend mode or hibernation mode. If no external display is attached when the computer resumes, the LCD remains blank and output is not displayed. This restriction does not depend on the resolution value.</b></p>
<p>Your computer does not enter suspend or hibernation mode.</p>	<p>Check if the suspend or hibernation mode is disabled. If you are using the AC Adapter and your computer is connected to a network, do the following:</p> <p><b>Windows 95:</b></p> <ol style="list-style-type: none"> <li>1. Start the ThinkPad Configuration program.</li> <li>2. Click on <b>Power Management</b> ().</li> <li>3. Click on <b>Hibernation</b> tab.</li> <li>4. Make sure that hibernation mode is enabled.</li> </ol> <p><b>Windows NT:</b></p> <ol style="list-style-type: none"> <li>1. Start the ThinkPad Configuration program.</li> <li>2. Click on <b>Power Management</b> ().</li> <li>3. Click on the <b>Suspend/Resume Options</b> ().</li> <li>4. Make sure that hibernation mode is enabled.</li> <li>5. Click on <b>OK</b>.</li> </ol>

## Troubleshooting Charts

Problem	Action
<p>The computer does not enter hibernation mode with the <b>Fn+F12</b> key combination.</p>	<p>Enable hibernation mode as follows:</p> <p><b>For Windows 95:</b></p> <ol style="list-style-type: none"> <li>1. Start the ThinkPad Configuration program.</li> <li>2. Click on <b>Power Management</b> ().</li> <li>3. Click on the <b>Hibernation</b> tab.</li> <li>4. Click on <b>Enable Hibernation</b>.</li> </ol> <p><b>Note:</b> If you have already created the hibernation file, this button is displayed in gray and you cannot click on it.</p> <ol style="list-style-type: none"> <li>5. Click on <b>Create Now</b>.</li> <li>6. Click on <b>OK</b>.</li> </ol> <p>The computer cannot enter hibernation mode when you are using one of the IBM communication PC Cards.</p> <p>To enter hibernation mode, stop the communication program, and then remove the PC Card or turn off power on the PC Card slot using the <b>Control Panel</b>.</p> <p><b>For Windows NT:</b></p> <p><b>Note:</b> You must format your hard disk with the FAT format system to use hibernation mode in Windows NT. If you format your hard disk with NTFS, the Windows NT default format, you cannot use hibernation mode.</p> <ol style="list-style-type: none"> <li>1. Start the ThinkPad Configuration program.</li> <li>2. Click on <b>Power Management</b> ().</li> <li>3. Click on <b>Suspend/Resume Options</b> ().</li> <li>4. Click on <b>Enable Hibernation</b>.</li> <li>5. Click on <b>OK</b>.</li> </ol> <p>The computer cannot enter hibernation mode when you are using one of the IBM communication PC Cards.</p>

## LCD Problems

Problem	Action
<p>The screen is unreadable or distorted.</p>	<p>Make sure that:</p> <p>The display driver is installed correctly by doing the following:</p> <ol style="list-style-type: none"> <li>1. Click on <b>Start</b> and move the cursor to <b>Settings, and Control Panel</b>.</li> <li>2. Click on <b>Control Panel</b>, and then double-click on <b>Display</b>.</li> <li>3. Select the <b>Settings</b> tab.</li> <li>4. Click on <b>Advanced Properties</b>. The “Adapter/Driver Information” window appears. Make sure the display driver information in the window is correct.</li> </ol> <p>The refresh rate setting is set to your display resolution and color depth by doing the following:</p> <ol style="list-style-type: none"> <li>1. Start the ThinkPad Configuration program.</li> <li>2. Click on <b>LCD</b> ().</li> <li>3. (For Windows 95) Click on <b>Properties....</b> (For Windows NT) Click on <b>Advanced....</b></li> <li>4. Make sure that the setting in the next window is correct.</li> <li>5. Click on <b>OK</b>.</li> </ol>
<p>Incorrect characters appear on the screen.</p>	<p>Did you install the operating system or application program correctly? If they are installed and configured correctly, have the computer serviced.</p>
<p>The screen stays on even after you power off your computer.</p>	<p>Press the power shutdown switch with the tip of a pen and turn off your computer; then turn it on again.</p>
<p>Missing, discolored, or bright dots appear on the screen every time you power on your computer (TFT display model.)</p>	<p>This is not a problem. It is an intrinsic characteristic of the TFT technology. Your computer display contains multiple thin-film transistors (TFTs). A small number of missing, discolored, or bright dots on the screen might exist all the time.</p>

## Troubleshooting Charts

### An Indicator Problem

Problem	Action
The battery status indicator does not go on even though a battery pack is installed in the computer.	The over-current protection device inside the battery pack has been activated. Wait several hours and try again. If the indicator does not appear, replace the battery pack or have the computer serviced.

### Battery Problems

Problem	Action
The battery pack cannot be fully charged in 3 hours by the power-off charging method.	The battery pack might be over-discharged. Do the following: <ol style="list-style-type: none"><li>1. Turn off the computer.</li><li>2. Make sure that the over-discharged battery pack is in the computer.</li><li>3. Connect the AC Adapter to the computer and let it charge.</li></ol> If the battery pack cannot be fully charged in 24 hours, use a new battery pack.
Your computer shuts down before the battery status indicator shows empty, <b>-or-</b> Your computer operates after the battery status indicator shows empty.	Repeat discharging and charging the battery pack at least three times.
The operating time for a fully charged battery pack is short.	Repeat discharging and charging of the battery pack three to six times. If you still have a problem, use a new battery pack.
The computer does not operate with a fully charged battery pack.	The over-current protective function in the battery pack might be activated. Turn off the computer for 1 minute to reset this function; then turn it back on again.

## CD-ROM Drive Problems

Problem	Action
The CD-ROM does not work.	<p>Make sure that:</p> <ul style="list-style-type: none"> <li>The computer power is turned on and a compact disc is in the CD-ROM drive.</li> <li>The CD-ROM drive tray is firmly closed.</li> <li>The device drivers are correctly installed.</li> </ul>
You hear a noise from the CD-ROM drive when the CD-ROM is spinning.	The CD-ROM drive cover might be bent. Have the computer serviced.
The CD-ROM tray does not open even if you press the CD-ROM eject button.	Insert a pin into the CD-ROM emergency eject hole and eject the CD-ROM tray.
The compact disc cannot be read.	<p>Make sure that:</p> <ul style="list-style-type: none"> <li>The compact disc is not dirty. If it is, clean it with a CD-ROM cleaner kit.</li> <li>The compact disc is not defective. If it is, try another compact disc.</li> <li>The compact disc is placed in the tray with the label side up.</li> <li>The compact disc format conforms with one of the following:                             <ul style="list-style-type: none"> <li>– Music CD</li> <li>– CD-ROM or CD-ROM XA</li> <li>– Multisession photo CD</li> <li>– Video CD</li> </ul> </li> </ul>

## Troubleshooting Charts

### Infrared Communication Problems

Problem	Action
Your computer cannot communicate with other devices using the infrared port.	<p>Make sure that:</p> <ul style="list-style-type: none"><li>The communication speeds are the same.</li><li>The infrared ports are clean and do not have any spots.</li><li>No objects are between the computer and the communicating device.</li><li>The distance and angle between your computer and the device is within the set range.</li><li>The other computer is the same model as yours.</li><li>You are not operating under direct sunlight.</li><li>The infrared port is not directly facing the other communicating port.</li><li>Communication is not impeded by the light from computer's LCD. To avoid this, open the LCD to a wide angle.</li><li>The communication application running on your computer is the same as that running on the other computer. Refer to the application manuals for more information.</li></ul>
Incorrect data is sent between your computer and a communicating device.	<p>Make sure that:</p> <ul style="list-style-type: none"><li>The distance and angle between your computer and the device is within the set range.</li><li>The communication speeds are the same.</li><li>There are no other devices that radiate infrared rays, such as remote-controlled devices or wireless headphones, near your computer or the communicating device.</li><li>You are not operating under direct sunlight.</li><li>No fluorescent lamps are near your computer or the communicating device.</li></ul>
How can I use DMA channels for both parallel port and infrared port?	<p>If you enable ECP and choose DMA3 (default value) for the parallel port, you might be prompted if you want to disable DMA for the infrared port. To use DMA channels for both parallel and infrared port, do the following:</p> <ol style="list-style-type: none"><li>1. Click on <b>OK</b> to disable DMA for the infrared port.</li><li>2. Close a parallel port panel.</li><li>3. Click on the <b>Infrared device</b> button to open the infrared panel.</li><li>4. Choose DMA0 or DMA1 for infrared port on the panel.</li><li>5. If you see the panel prompting if you want to disable DMA for an audio device, click on <b>OK</b>.</li></ol>



## A Universal Serial Bus (USB) Problem

Problem	Cause and Action
A device connected to the USB port does not work.	<p>1. Make sure that the USB device is connected correctly.</p> <p>2. Open the “Device Manager” window, and make sure that the USB device setup is correct, and that computer resource assignment and device driver installation are correct.</p> <p><b>Note:</b> To open the “Device Manager” window, click on <b>Start</b> and move the cursor to <b>Settings</b> and <b>Control Panel</b>. Click on <b>Control Panel</b> and double-click on <b>System</b>. Then click on the <b>Device Manager</b> tab in the “System Properties” window.</p> <p>Refer to “Testing Your Computer” on page 163 and run the diagnostic test for the USB port.</p>

## PC Card Problems

Problem	Action
The PC Card shows “Ready,” but it does not work correctly.	<p>Make sure that:</p> <p>The system resources reserved for the PC Card do not conflict with other system devices.</p> <p>Refer to the online book.</p> <p>The resources reserved for the PC Card match the settings in the application program.</p> <p>If you are using a modem card, check the COM number, I/O port address, and IRQ level. If you are using a network card, check the I/O port address, IRQ level, and memory window address. To check the resources assigned to the PC Card, click on <b>Status</b> in the Easy-Setup program.</p>
A system resource conflict occurred when a PC Card was used.	See the online book.

## Troubleshooting Charts

Problem	Action
<p>My PC Card modem does not work.</p>	<p>Make sure that the infrared port is disabled and the modem is set up correctly.</p> <p>Make sure that the COM port you set for the modem with the ThinkPad Configuration program is the same in the following procedure and that there is no resource conflict.</p> <p><b>For Windows 95:</b></p> <p>To set up the modem, do the following:</p> <ol style="list-style-type: none"> <li>1. Click on <b>Start</b> and move the cursor to <b>Settings</b> and <b>Control Panel</b>.</li> <li>2. Click on <b>Control Panel</b>, and then double-click on <b>Modem</b>. The "Modem Properties" window appears.</li> <li>3. Make sure the PC Card (PCMCIA) modem is in the window.</li> <li>4. Click on <b>Properties</b>, <i>not</i> <b>Dialing Properties</b>.</li> <li>5. Click on the <b>Connection</b> tab.</li> <li>6. Remove the check mark ( ) in the <b>Wait for dial tone before dialing</b> box if it is checked.</li> <li>7. Click on <b>Advanced</b>.</li> <li>8. If there is a check mark ( ) in the <b>Use error control</b> box, click and remove it.</li> <li>9. Add a check mark ( ) to the <b>Use flow control</b> by clicking on the box and make sure that the <b>Hardware (RTS/CTS)</b> is selected.</li> <li>10. Close the window by clicking on <b>OK</b>.</li> <li>11. Return to the "Modem Properties" window by clicking on <b>OK</b>.</li> <li>12. Click on <b>Dialing Properties</b> in the "Modem Properties" window, and fill in all boxes.</li> </ol> <p><b>Note:</b> Click on either <b>Tone dialing</b> or <b>Pulse dialing</b>. Most telephones today use tone dialing.</p> <ol style="list-style-type: none"> <li>13. Click on <b>OK</b>.</li> <li>14. Click on <b>Close</b> to close the window.</li> <li>15. Close all active windows.</li> </ol> <p>Run your modem application again.</p>
<p>I cannot use PC Cards other than IBM ones in the OS/2 Warp environment.</p>	<p>If you do not have the PC Card device driver for OS/2 but you have one for DOS, your PC Card might run in the VDM (virtual DOS machine) environment. Refer to "Virtual Card Services" for setting the VDM and the sample configuration files on the PCMCIA Installation Diskette for OS/2, Windows 95. (If the PCMCIA Installation Diskette for OS/2, Windows 95 did not come with the computer, create it using the Diskette Factory program.)</p>

## Troubleshooting Charts

Problem	Action
PC Card support software does not recognize your PC Card.	<p>Make sure that:</p> <p>If the PC Card is not a modem, an ATA, a Flash, or an SRAM card, you have the proper client device driver for the card. In Windows 95, you need to copy necessary INF files of the PC Card device driver (or option) diskette to C:\WINDOWS\INF directory prior to let CardWizard detect the PC Card.</p> <p>Your PC Card supports PCMCIA Release 2.0, 2.01, and 2.10. Refer to the manual that came with your PC Card.</p> <p>If your PC Card does not support PCMCIA Release 2.0, 2.01, or 2.10, you cannot use PC Card Director. Contact your PC Card supplier.</p> <p>Your PC Card is working by following the diagnostic instructions for your PC Card, if any.</p>
The PC Card is recognized by PC Card support software, but the "Not Ready" or "Not Configured" message is shown.	<p>Make sure that:</p> <p>The PC Card enabler is installed.</p> <p>Refer to the manuals supplied with your PC Card.</p> <p>If the PC Card is not a modem, ATA, flash, or SRAM card, you have the proper client device driver for the card. In Windows 95, the PC Card must have INF files associated with it.</p> <p>The resources for the PC Card are correctly reserved.</p> <p>Refer to the online book.</p>
You disabled the PCIC controller. Later you reenabled it in the Device Manager. Now the CardWizard does not work correctly.	<p>Before you run the CardWizard, correct the config.sys file as follows:</p> <ol style="list-style-type: none"> <li>1. Click on <b>Start</b>.</li> <li>2. Move the cursor over <b>Programs</b>; then click on <b>MS-DOS Prompt</b>.</li> <li>3. At the command prompts, type <code>cd. .</code> then press <b>Enter</b>.</li> <li>4. Type <code>edit config.sys</code> then press <b>Enter</b>.</li> <li>5. On each line where it occurs in the file, remove the following phrase: <code>REM - by PC Card (PCMCIA) wizard -</code> Don't remove the rest of the line.</li> <li>6. Save the updated config.sys file.</li> <li>7. Reboot your system.</li> </ol> <p>Now you can use the PC Card.</p>



## Troubleshooting Charts

Problem	Action
<p>The ATA PC Card does not run correctly.</p>	<p>If the ATA PC Card is set up in <i>CardSoft Mode</i>, there are some cards that the system cannot correctly recognize. Change the card driver to <i>Plug and Play</i> as follows:</p> <ol style="list-style-type: none"> <li>1. Click on <b>Start</b>.</li> <li>2. Move the cursor over <b>Programs</b> and <b>CardWorks</b>. Then click on <b>CardWizard</b>.</li> <li>3. Click on the right button in the card information window for the card driver that you want to change.</li> <li>4. Click on <b>Properties..</b> in the pop-up window.</li> <li>5. Click on <b>Drivers</b>.               <ol style="list-style-type: none"> <li>a) Add a check mark in the box next to <b>Change Card Driver</b> by clicking on it.</li> <li>b) Click on <b>Use Plug and Play</b>; then click on <b>OK</b>.</li> </ol> </li> <li>6. Click on <b>OK</b> in the next window.</li> <li>7. Remove the ATA PC Card, and then reinstall it.</li> </ol> <p>Now you can use the ATA PC Card.</p>
<p>If the PC Card is installed and configured but does not work, try the following actions:</p>	<p><b>Modem card:</b> Make sure all settings in the "Modem Control" panel and in your communication application correspond and are correct.</p> <p><b>SCSI card:</b> Make sure the correct driver for the SCSI card is installed.</p> <p><b>Note:</b> SCSI cards can be inserted while you are operating your computer, however, it is recommended that you insert them at boot time.</p> <p><b>Network card:</b> Make sure all network components are correctly installed.</p> <p><b>Combo card:</b> Make sure the correct driver for the Combo card is installed. Reboot the system, and then insert the Combo card.</p>



## A Printer Problem

Problem	Action
The printer does not work.	<p>Make sure that:</p> <ul style="list-style-type: none"> <li>The parallel port is enabled.</li> <li>1. Start the ThinkPad Configuration program.</li> <li>2. Click on <b>Parallel Port</b> ().</li> <li>3. Select <b>Enable</b>.</li> <li>4. Click on <b>OK</b>.</li> </ul> <p>The printer is turned on and ready to print. The printer signal cable is connected to the correct connector of your computer.</p> <p>If these items are correct and the printer still does not work, run the tests described in the printer manual. If the tests show that the printer is OK, have the computer serviced.</p>

## External Monitor Problems

Problem	Action
The external monitor is blank.	<p>Do the following:</p> <ol style="list-style-type: none"> <li>1. Connect the external monitor to another computer to make sure it works.</li> <li>2. Reconnect the external monitor to your computer.</li> <li>3. Start the ThinkPad Configuration program.</li> <li>4. Click on <b>External Display</b> () or <b>LCD + External Display</b> () on the toolbar in the ThinkPad Configuration program.</li> </ol> <p>If nothing appears on the external monitor, have it serviced.</p>

## Troubleshooting Charts

Problem	Action
<p>You cannot set a higher resolution than the present one on your external monitor.</p>	<p>Make sure that:</p> <p>The ThinkPad display driver is installed correctly.</p> <ol style="list-style-type: none"> <li>1. Click on <b>Start</b> and move the cursor to <b>Settings</b> and <b>Control Panel</b>.</li> <li>2. Click on <b>Control Panel</b> and then double-click on <b>Display</b>.</li> <li>3. Select the <b>Settings</b> tab in the "Display Properties" window.</li> <li>4. Click on <b>Advanced Properties</b>. The "Adapter/Driver Information" window appears. Make sure that the ThinkPad display driver is installed.</li> </ol> <p>If you are not sure that the ThinkPad display driver is installed correctly, reinstall it.</p> <p>An appropriate display type or refresh rate is selected.</p> <ol style="list-style-type: none"> <li>1. Start the ThinkPad Configuration program.</li> <li>2. Click on <b>LCD</b> ().</li> <li>3. (For Windows 95) Click on <b>Properties....</b> (For Windows NT) Click on <b>Advanced....</b></li> <li>4. Make sure the setting in the next window is correct.</li> <li>5. Click on <b>OK</b> to close the window.</li> </ol>
<p>The screen is unreadable or distorted.</p>	<p>Make sure that:</p> <p>The ThinkPad display driver is installed correctly by doing the following:</p> <ol style="list-style-type: none"> <li>1. Click on <b>Start</b> and move the cursor to <b>Settings</b> and <b>Control Panel</b>.</li> <li>2. Click on <b>Control Panel</b> and then double-click on <b>Display</b>.</li> <li>3. Select the <b>Settings</b> tab in the "Display Properties" window.</li> <li>4. Click on <b>Advanced Properties</b>. The "Adapter/Driver Information" window appears. Make sure that the ThinkPad display driver is installed.</li> </ol> <p>The display is set correctly by doing the following:</p> <ol style="list-style-type: none"> <li>1. Start the ThinkPad Configuration program.</li> <li>2. Click on <b>LCD</b> ().</li> <li>3. (For Windows 95) Click on <b>Properties....</b> (For Windows NT) Click on <b>Advanced....</b></li> <li>4. Make sure the setting in the next window is correct.</li> <li>5. Click on <b>OK</b> to close the window.</li> </ol> <p>If the settings are correct, run the tests described in the manual supplied with the external monitor. If the tests show that the external monitor is OK, have the computer serviced.</p>
<p>Wrong characters appear on the screen.</p>	<p>Did you install the operating system or application program with the correct procedure?</p> <p>If you did, have the external monitor serviced.</p>

## Port Replicator Problems

Problem	Action
The computer hangs when you power on or resume operation.	Make sure that: The AC Adapter is connected to the port replicator. The power-on indicator of the port replicator is on. The computer is securely attached to the port replicator. If there is still a problem, have the port replicator serviced.

## Troubleshooting Charts

Problem	Action
<p>The PC Card installed in a port replicator is not recognized and the PC Card slots are unusable.</p>	<p>Make sure that:</p> <ul style="list-style-type: none"> <li>The AC Adapter is connected to the port replicator.</li> <li>The power-on indicator of the port replicator is on.</li> <li>The computer is securely attached to the port replicator.</li> </ul> <p>This problem might happen when you reinstall Windows 95, or when you initialize the system with Easy-Setup.</p> <p>Do the following procedure to confirm the settings of Windows 95:</p> <ol style="list-style-type: none"> <li>1. Shut down Windows 95 and turn off the computer.</li> <li>2. Connect the AC Adapter to the port replicator and attach the computer to the port replicator.</li> <li>3. Turn on the computer and start Windows 95</li> <li>4. Click on <b>Start</b> and move the cursor to <b>Settings</b> and <b>Control Panel</b>. Then click on <b>Control Panel</b> and double-click on <b>System</b>.</li> <li>5. Click on the <b>Device Manager</b> tab, and double-click on <b>System Device</b> and <b>PCI Bus</b>.</li> <li>6. Click on the <b>Settings</b> tab, and confirm that "Use BIOS" is selected. If not, click on "USE BIOS."</li> <li>7. Click on <b>IRQ Steering</b>, and confirm that check marks are added in checkboxes of both <b>Use IRQ Steering</b> and <b>Get IRQ table from PCIBIOS 2.1 call</b>. If not, add check marks in both boxes.</li> <li>8. Click on <b>OK</b> twice.</li> <li>9. Follow the instructions on the screen and restart Windows 95.</li> </ol> <p>This problem might also happen when you install a PC Card in a port replicator for the first time.</p> <p>To avoid this problem, do as follows:</p> <ol style="list-style-type: none"> <li>1. Click on <b>Start</b> and move the cursor to <b>Settings</b> and <b>Control Panel</b>.</li> <li>2. Click on <b>Control Panel</b> and double-click on <b>System</b>.</li> <li>3. Click on the <b>Device Manager</b> tab.</li> <li>4. Click on <b>Refresh</b> and <b>OK</b>.</li> </ol>





## Troubleshooting Charts

Problem	Action
The MIDI port of a port replicator does not work.	<p>To enable the MIDI port of a port replicator, use the ThinkPad Configuration program. Make sure that the MIDI port is enabled by doing the following procedure:</p> <ol style="list-style-type: none"><li>1. Start ThinkPad Configuration program.</li><li>2. Click on <b>MIDI Port</b>.</li><li>3. Confirm that the MIDI port is enabled. If not, click on <b>Enable</b>; then click on <b>OK</b>.</li><li>4. Close the ThinkPad Configuration program and restart the computer.</li></ol> <p><b>Note:</b> When you restart the computer, the installation of a MIDI device driver may be required. Follow the instructions on the screen and install the device driver for your computer's operating system.</p>

## Other Option Problems

Problem	Action
An IBM option that you just installed does not work.	<p>Make sure that:</p> <ul style="list-style-type: none"><li>The option is designed for your computer.</li><li>The option was installed following to the instructions supplied with the option or this book.</li><li>Other installed options or cables are not loose.</li><li>There is no I/O address or interrupt level (IRQ) DMA channel conflict. To see the system resource status, start the ThinkPad Configuration program and click on the respective device buttons.</li></ul> <p>If the test program for the option did not find the problem, have the computer and option serviced.</p>
An IBM option that used to work no longer works.	<p>Make sure that:</p> <ul style="list-style-type: none"><li>The option is securely connected to your computer.</li><li>The option passes its own test. If the option came with its own test instructions, use those instructions to test the option.</li><li>There is no system resource conflict (see the online book).</li></ul> <p>If these items are correct and the test program did not find the problem, have the computer and option serviced.</p>

## Troubleshooting Charts

Problem	Action
The serial port does not work.	<p>Make sure that the serial port is enabled by doing the following:</p> <p><b>For Windows 95:</b></p> <ol style="list-style-type: none"><li>1. Start the ThinkPad Configuration program.</li><li>2. Click on <b>Serial Port</b> ().</li><li>3. Select <b>Enable</b>.</li><li>4. Click on <b>Device Manager</b>.</li><li>5. Set up the port in the "Device Manager" window.</li><li>6. Click on <b>OK</b>.</li></ol> <p><b>For Windows NT:</b></p> <ol style="list-style-type: none"><li>1. Start the ThinkPad Configuration program.</li><li>2. Click on <b>Serial Port</b> ().</li><li>3. Select <b>Enable</b>; then select <b>COM1</b>, <b>COM2</b>, <b>COM3</b>, or <b>COM4</b>.</li><li>4. Click on <b>OK</b>.</li></ol>

## Software Problems

Problem	Action
<p>An application does not run correctly.</p>	<p>Check the following to make sure that the problem is not being caused by the application:</p> <ul style="list-style-type: none"> <li>Your computer has the minimum required memory to run the application. Refer to the manuals supplied with the application.</li> <li>The application is designed to operate with your operating system.</li> <li>Other applications run correctly on your computer.</li> <li>The necessary device drivers are installed (see the online book).</li> <li>The application works OK when it is run on some other computer.</li> </ul> <p>If an error message appears when you are using the application program, refer to the manuals supplied with the application.</p> <p>If these items are correct and you still have a problem, contact your place of purchase or the service representative for help.</p>
<p>You cannot install OS/2 Warp.</p>	<p>See the online book.</p>
<p>An MS-DOS game might encounter such problem as not running or stopping.</p>	<p>Such problems are typically caused by shortage of conventional memory for the SystemSoft PCMCIA real mode drivers. If the system starts in MS-DOS mode without changing the system configuration at the time of purchase, these drivers are not loaded. Therefore, there is no problem with playing an MS-DOS game.</p> <p>Restart the system in MS-DOS mode, as follows:</p> <ol style="list-style-type: none"> <li>1. Click on <b>Start</b>.</li> <li>2. Click on <b>ShutDown</b>.</li> </ol> <p>The Shut Down window appears.</p> <ol style="list-style-type: none"> <li>3. Click on <b>Restart the computer in MS-DOS mode?</b></li> <li>4. Click on <b>Yes</b>.</li> </ol> <p>The system restarts in MS-DOS mode. Run the game in this mode.</p>

## Troubleshooting Charts

### Other Problems

Problem	Cause or Action
The computer locks or does not accept any input.	Your computer might lock when it enters suspend mode during a communication operation. You should disable the suspend timer when you are working on the network. When you turn on the computer with OS/2 Warp installed, make sure no compact disc (CD) is in the CD-ROM drive. If there is, remove the CD, turn off the computer, and turn it on again. To turn off the computer, press the power shutdown switch using the tip of a ballpoint pen.
The computer does not turn off with the power switch.	If the suspend lamp is on and you are working under battery power, change the battery to a fully charged one or change your power source to AC power. If you still have a problem, press the power shutdown switch using the tip of a ballpoint pen.
The computer does not start from a diskette.	Make sure that the startup sequence in Easy-Setup is set so that the computer boots from the diskette drive (see page 28).
Performance degrades when the computer gets hot during use.	The processor speed might decrease under the following conditions: Use in a hot environment High-powered processing that requires high-power consumption This is not a defect.
A memory shortage or memory error occurs.	If you are using DOS: <ol style="list-style-type: none"><li>1. Use the DOS command <code>MEM /C</code> to review your DOS memory usage occasionally.</li><li>2. Unload any unnecessary drivers from the CONFIG.SYS file. (For example, unload printer drivers if you do not use a printer.)</li><li>3. Reconfigure the UMB (upper memory block) using the <code>DEVICEHIGH</code> statement.</li><li>4. Use the multiple configuration setup for DOS (refer to the documents supplied with DOS).</li></ol> If you are using Windows 3.11: <ol style="list-style-type: none"><li>1. Try the same actions as described for DOS.</li><li>2. Unload any unnecessary programs from the WIN.INI file (for example, FUELWIN for AC operations.)</li></ol>

## Testing Your Computer

If you still have a problem with your computer after using the Troubleshooting Charts, test the computer using the Easy-Setup **Test** function.

To test your computer, do the following:

- 1** Make sure that the speaker volume control is in the middle position.
- 2** Press and hold **F1**; then turn on the computer to start Easy-Setup. Hold **F1** until the “Easy-Setup” menu appears:

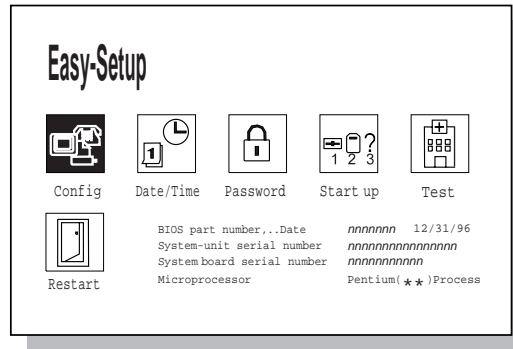

You will hear a short beep. If you are not sure whether you heard a beep, turn off the computer and try again. If you still don't hear a beep, the speaker is not working. Have your computer serviced.

## Testing Your Computer

- 3 Select the **Test** icon; then select the **Start** icon or press **Enter**.

**Note:** Do not touch the keyboard or the pointing device during the test.

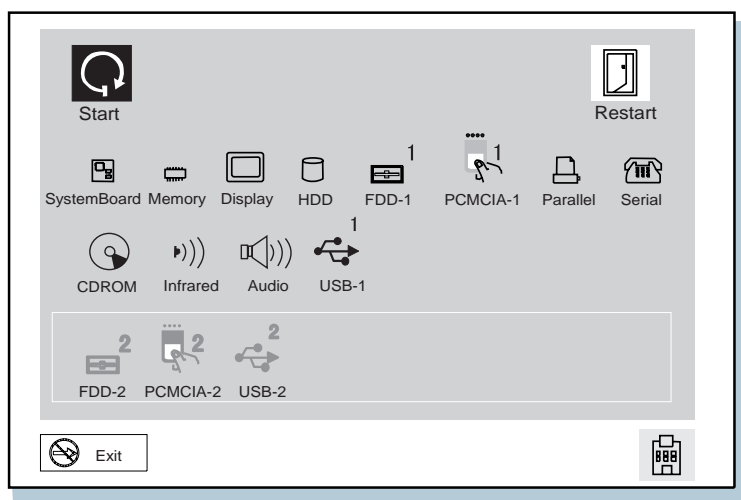

If you cannot go to the next menu, have the computer serviced.

If an X appears to the left of a device with an error code below it, make a note of the error code and have the computer serviced.

## Recovering Lost or Damaged Software

This section describes how to recover lost or damaged software. If you want to recover one or several pieces of software, use the Diskette Factory. If you want to restore your system to what it was at the time of purchase, and if you are using Windows 95, use the Recovery CD.

### Using the Diskette Factory

To recover a particular device driver or utility, create the backup diskettes for it with the Diskette Factory; then reinstall it.

To create the backup diskettes, do the following:

- 1** Double-click on **ThinkPad Tools**.  (ThinkPad Tools)
- 2** Double-click on **Diskette Factory**.

The “Diskette Factory” window appears:



## Recovering Lost or Damaged Software

- 3 Select the operating system you are installing and click on **Yes**.

The following window appears:

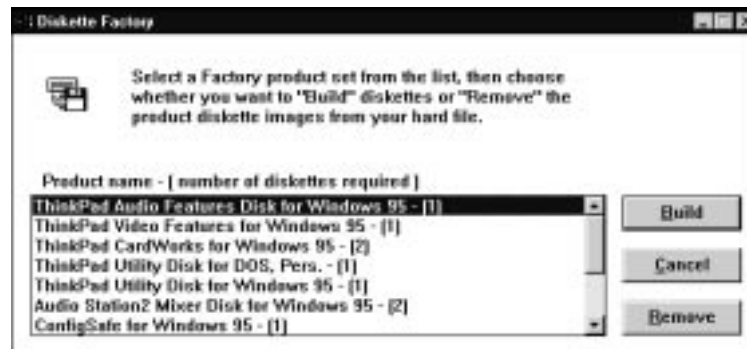

- 4 Click on the diskette group for the backup copy you want to create. Then click on **Build**.

You need to create all the diskettes for each group.

### Note

You need blank diskettes. The number of diskettes required is shown beside the diskette group.

For details on how to install software, see the online book.



## Using the Recovery CD (Windows 95 Only)

The Recovery CD package consists of a boot diskette and a CD-ROM containing the original preload image.

### Attention

This CD deletes all personal data and your customized configuration setting, resetting your computer to most of the factory-shipped default values. You should back up your personal files before you use this CD.

- 1** Insert the Recovery CD Boot Diskette into the diskette drive.
- 2** Turn on or restart the computer.  
Your hard disk is formatted.
- 3** Insert the CD-ROM into the CD-ROM drive.
- 4** Follow the instruction that appears on the screen.
- 5** When the process is complete, remove the Recovery CD-ROM Boot Diskette from the diskette drive.
- 6** Press **Restart**.  
Your computer restarts with the original preloaded software and hardware configuration.

*Recovering Lost or Damaged Software*

## Chapter 6. Getting Service

---

Information on Your Computer . . . . .	171
Option List . . . . .	171
Identification Numbers . . . . .	171
Problem Recording Sheet . . . . .	172
HelpWare Customer Support and Service . . . . .	173
Help by Telephone . . . . .	173
ThinkPad EasyServ . . . . .	174
Getting Help around the World . . . . .	174
Fax Information . . . . .	175
Electronic Support Services . . . . .	175
Purchasing Additional Services . . . . .	177
Enhanced PC Support Line . . . . .	177
Client Support Line . . . . .	178
Network and Server Support Line . . . . .	178
Ordering Support Line Services . . . . .	178
Warranty and Repair Services . . . . .	179
Obtaining IBM Operating System Updates . . . . .	180
Getting Update Diskettes . . . . .	180
Ordering Publications . . . . .	180

## Getting Service

### Preparation

If you need further assistance, call your IBM authorized reseller or IBM marketing representative.

You will need to know the following information when requesting repair service:

- Identification number of your computer
- Options installed in your system

**Note:** Use the checklist on page 171.

- Error message or problem

**Note:** Error messages can help identify which service action is required and help the service representative provide quick and efficient service.

Use the record sheet on page 172.

### About Your Warranty

During the warranty period, you may be responsible for repair costs if the product damage was due to misuse, accident, modification, unsuitable physical or operating environment, or improper maintenance.

For full information on product warranties, see Appendix B.

For your convenience, write the service phone numbers here:

---

---

---

---

## Information on Your Computer

### Option List

DIMM

\_\_\_\_\_ MB

\_\_\_\_\_ MB

\_\_\_\_\_ MB Hard Disk Drive

PC Cards

\_\_\_\_\_  
\_\_\_\_\_

Battery Pack

### Identification Numbers

The serial number label is on the bottom of your computer. Write down the machine **Type** and the serial number (**S/N**) in the following box:

IBM Product Name	ThinkPad 380XD/385XD
Machine Type	2635- _____
Serial Number	_____

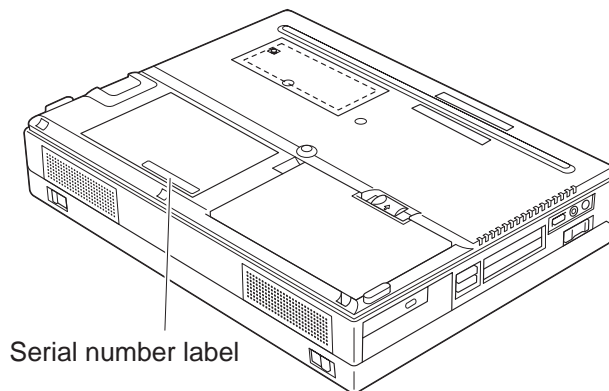

## Problem Recording Sheet

Computer information:

Machine type: \_\_\_\_\_

Serial number: \_\_\_\_\_

Date of purchase: \_\_\_/\_\_\_/\_\_\_

Type of problem:

Continuous problem

Intermittent problem

Error code:

\_\_\_\_\_

The operating system and its version number, if available:

DOS Version \_\_\_\_\_

Windows 3.11

Windows NT Version \_\_\_\_\_

OS/2 Version \_\_\_\_\_

Windows 95

Application programs running at the time of the problem:

\_\_\_\_\_  
\_\_\_\_\_

Problem symptom:

Describe the problem more specifically.

\_\_\_\_\_  
\_\_\_\_\_  
\_\_\_\_\_

Can the symptom be reproduced?

Yes      No

If yes, describe how it can be reproduced:

\_\_\_\_\_  
\_\_\_\_\_

## **HelpWare Customer Support and Service**

Purchasing an IBM PC hardware product entitles you to receive support and services during the limited warranty period. If you need additional support and services, a wide variety of extended solutions that address most needs are available for purchase.

### **Help by Telephone**

You can get support and information by telephone during the limited warranty period at no additional charge, through the IBM PC Support Line. Experienced technical-support representatives will be on hand to assist you in answering any questions you might have, such as:

- How to set up your computer
- How to install and set up your IBM options purchased directly from IBM or through an IBM reseller
- How to use the 30-day support for the preloaded operating system
- How to get service

Please have the following information ready when you call:

- Serial number of your computer and proof of purchase
- Description of the problem
- Exact wording of the error message
- Hardware and software configuration information for your system

If possible, be at your computer when you call:

In the U.S. and Puerto Rico, call 1-800-772-2227.

In Canada, call 1-800-565-3344.

These lines are available 24 hours a day, 7 days a week. The answering technical-support representative can also fax or mail you technical or product information, such as:

- Sales information
- Product brochures
- Location of IBM resellers
- Services available from IBM

## **ThinkPad EasyServ**

ThinkPad *EasyServ* is a courier repair service for IBM mobile products whereby your ThinkPad computer will be picked up, sent to IBM for repair, and then returned to the location of your choice. This service is available at no additional charge during the limited warranty period. Most computers can be repaired the day that it arrives at the IBM repair location.

Support personnel first try to solve your problem over the phone. If they are unsuccessful, you can arrange for EasyServ service by calling the PC Support Line.

If possible, you should use the original ThinkPad shipping materials that your computer came in, for re-sending it to IBM. If the box is not available, the courier will deliver a shipping carton and will return later to pick it up. This service is available only in the U.S. and Canada.

## **Getting Help around the World**

If you make frequent overseas trips or you are residing abroad, you can register with the International Warranty Service Office. The office will issue an International Warranty



## ***HelpWare Customer Support and Service***

Service Certificate, which you can use wherever IBM or IBM resellers sell and service IBM PC products.

For more information on registering with the International Warranty Service Office, call 1-800-497-7426 in the U.S. or Canada.

### **Fax Information**

In the U.S. and Canada, if you have a touch-tone telephone and access to a fax machine, you can receive marketing and technical information on such topics as computer hardware, operating systems, and local area networks (LANs) by fax. You can call the IBM PC Company Automated Fax System 24 hours a day, 7 days a week. Follow the recorded instructions, and the information that you request will be sent your fax machine.

To access the IBM PC Company Automated Fax System, call:

In the U.S., 1-800-426-3395  
In Canada, 1-800-465-3299

### **Electronic Support Services**

If you have a modem, you can access such public information services as the electronic bulletin boards and messaging areas, electronic conferences, and searchable databases available in several of the most popular online information services.

Bulletin boards and online services contain information on many topics such as:

- PC user groups
- PC questions and answers
- OS/2 topics

## **Purchasing Additional Services**

Problem solving  
Technical information  
Hardware and software configurations  
Networking

The IBM PC Company Bulletin Board System (BBS) can be reached 24 hours a day, 7 days a week. Modem speeds of up to 14,400 baud are supported. Long-distance telephone charges may apply.

To access the PC Company BBS, call:

In the U.S., 1-919-517-0001

For Canada, call the center closest to you:

- 905-316-4255 (Markham, Ontario)
- 514-938-3022 (Montreal)
- 416-492-1823 (Toronto)
- 604-664-6466 (Vancouver)

Commercial online services that have information on IBM products are:

CompuServe:

Use the **GO** word **ThinkPad**.

Prodigy:

Use the **Jump** command; type **IBM** and select **PC Product Support**.

America Online:

Use the **Go to** keyword **IBM**.

You can also contact us on the Internet for answers to your technical support questions. When you link to our support home page, you can search for technical tips, download up date drivers and find out about many other things. You can visit the site at the URL:

<http://www.us.pc.ibm.com/support>

## **Purchasing Additional Services**

During and after the limited warranty period, you can purchase additional services, such as:

- Support for IBM and non-IBM hardware, operating systems, and application programs
- Network setup and configuration
- Upgraded or extended hardware repair services
- Custom installation

The availability of the service and its name might vary by country.

### **Enhanced PC Support Line**

Enhanced PC Support is available for desktop and mobile IBM computers that are not connected to a network. Technical support is provided for IBM computers and IBM or non-IBM options, operating systems, and application programs on the supported products list.

This service includes technical support for the following:

- Installing and configuring your out-of-warranty IBM computer
- Installing and configuring non-IBM options in IBM computers
- Assistance with the preloaded operating system
- Using selected application software and games
- Tuning performance, such as memory management
- Installing device drivers remotely
- Setting up and using multimedia devices
- Identifying system problems
- Interpreting documentation

You can purchase this service for a single incident or for multiple incidents. For more information about purchasing the Enhanced PC Support, see “Ordering Support Line Services” on page 178.

## ***Purchasing Additional Services***

### **Client Support Line**

Client support is available to provide assistance with the following:

- Installation and configuration of clients

- Identification of system problems related to the client in a network environment

- Assistance with client network interface cards and options

You can purchase this service as a single incident.

### **Network and Server Support Line**

Network and Server Support includes all the features of the Enhanced PC Support Line and is available for simple and complex networks made up of IBM workstations and servers using major network operating systems. This line also supports the many popular non-IBM adapters and network interface cards.

This service includes technical support for the following:

- Installing and configuring client workstations and servers

- Identifying system problems and correcting problems on the client or the server

- Using IBM and non-IBM network operating systems

- Interpreting documentation

You can purchase this service for a single incident or for multiple incidents. For more information about purchasing Network and Server Support, see "Ordering Support Line Services."

### **Ordering Support Line Services**

Enhanced PC Support Line, Client Support Line, and the Network and Server Support Line services are available for products on the Supported Products list.

## ***Purchasing Additional Services***

To receive a Supported Products list,

In the U.S.:

- Call 1-800-772-2227.
- Select the automated fax system option.
- Select the service for which you would like a Supported Products list:

- For Enhanced PC Support Line, select document 11682.
- For Network and Server Support Line, select document 11683.

In Canada:

- Call 1-800-465-7999 or 1-800-465-3299

In other countries, contact your IBM reseller or IBM marketing representative.

For more information on how to purchase the Support Line Services:

In the U.S.: call 1-800-772-2227.

In Canada: call 1-800-465-7999.

In other countries, contact your IBM reseller or IBM marketing representative.

## **Warranty and Repair Services**

You can upgrade your ThinkPad EasyServ/Customer Carry-In warranty services or extend their period of service.

Upgradable warranties for the U.S. include:

Overnight service option. You can upgrade your current warranty that provides ThinkPad EasyServ/Carry-in repair service. Your warranty provides ThinkPad EasyServ/Carry-in repair service.

## ***Obtaining IBM Operating System Updates***

You can also extend your period of warranty. The “Warranty and Repair Services” offers a ThinkPad EasyServ Maintenance Agreement.

For more information on warranty upgrades and extensions:

In the U.S.: call 1-800-426-7697.

In Canada: call 1-800-465-7999.

In other countries, contact your IBM reseller or IBM marketing representative.

## **Obtaining IBM Operating System Updates**

IBM provides update diskettes, called ServicePaks or corrective service diskettes (CSDs), to customers who report a DOS or OS/2 problem for which there is or will be a corrective program.

### **Getting Update Diskettes**

You can obtain update diskettes from:

IBM PC Company BBS (refer to page 175.)

IBM Software Solutions Center (1-800-992-4777 for the U.S. and Canada)

An IBM authorized reseller or an IBM marketing representative

### **Ordering Publications**

Additional publications are available for purchase from IBM. For a list of publications available in your country:

In the U.S. and Puerto Rico: call IBM PC Books at 1-800-426-7282.

In Canada: call 1-800-465-1234.

In other countries, contact your IBM authorized reseller or IBM marketing representative.

## Appendix A. Features and Specifications

This appendix describes features and specifications for the computer.

### Features

*ThinkPad 380XD*

	12.1-inch HPA Model	12.1-inch TFT Model	12.1-inch TFT Model
<b>Microprocessor</b>	Intel Pentium 233 MHz with MMX technology	Intel Pentium 233 MHz with MMX technology	Intel Pentium 266 MHz with MMX technology
<b>Memory (base and max.)</b>	32 MB and 96 MB	32 MB and 96 MB	32 MB and 96 MB
<b>Hard disk drive</b>	3.2 GB	4.0 GB	5.1 GB
<b>CD-ROM drive</b>	10X–24X	10X–24X	10X–24X
<b>Diskette drive</b>	1.44 MB 3-mode	1.44 MB 3-mode	1.44 MB 3-mode
<b>Display</b>	12.1-inch SVGA HPA, up to 16M colors	12.1-inch SVGA TFT, up to 16M colors	12.1-inch SVGA TFT, up to 16M colors
<b>Audio</b>	CS4237B	CS4237B	CS4237B
<b>Infrared ports</b>	4 Mbps	4 Mbps	4 Mbps
<b>Universal serial bus</b>	Yes	Yes	Yes
<b>CardBus/ZV</b>	Yes/Yes	Yes/Yes	Yes/Yes
<b>Pointing device</b>	TrackPoint III	TrackPoint III	TrackPoint III
<b>Battery</b>	Lithium-ion	Lithium-ion	Lithium-ion
<b>AC Adapter</b>	56 W	56 W	56 W

## Features and Specifications

### *ThinkPad 385XD*

	<b>12.1-inch HPA Model</b>	<b>12.1-inch HPA Model</b>
<b>Microprocessor</b>	Intel Pentium 233 MHz with MMX technology	Intel Pentium 266 MHz with MMX technology
<b>Memory (base and max.)</b>	32 MB and 96 MB	32 MB and 96 MB
<b>Hard disk drive</b>	2.1 GB	3.2 GB
<b>CD-ROM drive</b>	10X–24X	10X–24X
<b>Diskette drive</b>	1.44 MB 3-mode	1.44 MB 3-mode
<b>Display</b>	12.1-inch SVGA HPA, up to 16M colors	12.1-inch SVGA HPA, up to 16M colors
<b>Audio</b>	CS4237B	CS4237B
<b>Infrared ports</b>	4 Mbps	4 Mbps
<b>Universal serial bus</b>	Yes	Yes
<b>CardBus/ZV</b>	Yes/Yes	Yes/Yes
<b>Pointing device</b>	TrackPoint III	TrackPoint III
<b>Battery</b>	Lithium-ion	Lithium-ion
<b>AC Adapter</b>	56 W	56 W

## Specifications

### **Size**

Width: 300 mm (11.8 in.)

Depth: 233 mm ( 9.2 in.)

Height: 62 mm ( 2.4 in.)

### **Weight**

Minimum configuration with battery pack: 3.2 kg (7.1 lb)

### **Environment**



## Features and Specifications

**Note:**

When you charge the battery pack, its temperature must be at least 10°C (50°F).

Temperature (at altitudes less than 2438 m [8000 ft]):

- Operating with no diskette: 5° to 35°C (41° to 95°F)
- Operating with a diskette: 10° to 35°C (50° to 95°F)
- Nonoperating: 5° to 43°C (41° to 109°F)

Relative humidity:

- Operating with no diskette in the drive: 8% to 95%
- Operating with a diskette in the drive: 8% to 80%

Maximum altitude: 3048 m (10,000 ft) in unpressurized conditions

- Maximum temperature at 3048 m (10,000 ft): 31.3°C (88° F)

**Heat output**

56 W (191 BTUs/hour) maximum

**Electrical (AC Adapter)**

Sine-wave input, at 50 to 60 Hz, is required

The input rating of the AC Adapter: 100–240 V ac, 50/60 Hz

**Lithium-ion battery pack**

Nominal voltage: 10.8 V dc

Capacity: 2.6 AH

## Features and Specifications

### IBM Power Cords

IBM power cords for a specific country are usually available only in that country:

For 2-pin power cords:

<b>IBM Power Cord Part Number</b>	<b>Used in These Countries</b>
13H5264	Bahamas, Barbados, Bermuda, Bolivia, Canada, Cayman Islands, Colombia, Costa Rica, Dominican Republic, Ecuador, El Salvador, Guatemala, Guyana, Haiti, Honduras, Jamaica, Korea (South), Mexico, Netherlands Antilles, Nicaragua, Panama, Peru, Philippines, Saudi Arabia, Suriname, Taiwan, Thailand, Trinidad (West Indies), United States of America, Venezuela
13H5267	Abu Dhabi, Albania, Antigua, Bahrain, Brunei, Dubai, Fiji, India, Ireland, Kenya, Kuwait, Macao, Malaysia, Nigeria, Oman, People's Republic of China (including Hong Kong), Qatar, Singapore, United Kingdom
13H5270	Austria, Belgium, Bulgaria, Chile, Czech Republic, Denmark, Egypt, Finland, France, Germany, Greece, Hungary, Iceland, Indonesia, Israel, Italy, Netherlands, Norway, Poland, Portugal, Romania, Slovakia, Spain, Sweden, Switzerland, Turkey, former Yugoslavia
13H5273	Japan
13H5276	Argentina, Australia, New Zealand, Papua New Guinea, Paraguay, Uruguay
13H5279	Bangladesh, Pakistan, South Africa, Sri Lanka

## Features and Specifications

For 3-pin power cords:

<b>IBM Power Cord Part Number</b>	<b>Used in These Countries</b>
76H3514	Argentina, Australia, New Zealand, Papua New Guinea, Paraguay, People's Republic of China (other than Hong Kong), Uruguay
76H3516	Aruba, Bahamas, Barbados, Bermuda, Bolivia, Brazil, Canada, Cayman Islands, Colombia, Costa Rica, Curacao, Dominican Republic, Ecuador, El Salvador, Guatemala, Guyana, Haiti, Honduras, Jamaica, Korea (South), Liberia, Mexico, Netherlands Antilles, Nicaragua, Panama, Peru, Philippines, Saudi Arabia, Suriname, Taiwan, Trinidad (West Indies), United States of America, Venezuela
76H3518	Austria, Belgium, Bulgaria, Czech Republic, Egypt, Finland, France, Germany, Greece, Hungary, Iceland, Indonesia, Macao, Netherlands, Norway, Poland, Portugal, Romania, Slovakia, Spain, Sweden, Turkey, former Yugoslavia
76H3520	Denmark
76H3522	Bangladesh, Pakistan, Myanmar, South Africa, Sri Lanka
76H3524	Abu Dhabi, Albania, Antigua, Bahrain, Brunei, Dubai, Fiji, India, Ireland, Kenya, Kuwait, Malaysia, Nigeria, Oman, People's Republic of China (Hong Kong), Qatar, Singapore, United Kingdom
76H3526	Japan
76H3528	Switzerland, Liechtenstein
76H3530	Chile, Italy, Ethiopia, Libya
76H3532	Israel
76H3535	Korea

## Features and Specifications

**Note**

The grounded adapter is required for full MPRII compliance. If a 3-pin power cord came with your computer, see “Safety Information” on page viii.

## Appendix B. Product Warranties and Notices

International Business Machines Corporation

Armonk, New York 10504

### Statement of Limited Warranty

*The warranties provided by IBM in this Statement of Limited Warranty apply only to Machines you originally purchase for your use, and not for resale, from IBM or an IBM authorized reseller. The term "Machine" means an IBM machine, its features, conversions, upgrades, elements, or accessories, or any combination of them. Machines are subject to these terms only if purchased in the United States or Puerto Rico, or Canada, and located in the country of purchase. If you have any questions, contact IBM or your reseller.*

**Machine:** IBM ThinkPad 380XD or 385XD and the Battery Pack

**Warranty Period\*:** One Year

*\*Elements and accessories are warranted for three months. Contact your place of purchase for warranty service information.*

### Production Status

Each Machine is manufactured from new parts, or new and serviceable used parts (which perform like new parts). In some cases, the Machine may not be new and may have been previously installed. Regardless of the Machine's production status, IBM's warranty terms apply.

### The IBM Warranty

IBM warrants that each Machine 1) is free from defects in materials and workmanship and 2) conforms to IBM's Official Published Specifications. IBM calculates the expiration of the warranty period from the Machine's Date of Installation. The date on your receipt is the Date of Installation, unless IBM or your reseller informs you otherwise.

During the warranty period, IBM or your reseller will provide warranty service under the type of service designated for the Machine and will manage and install engineering changes that apply to the Machine. IBM or your reseller will specify the type of service.

For a feature, conversion, or upgrade, IBM or your reseller may require that the Machine on which it is installed be 1) the designated, serial-numbered Machine and 2) at an engineering-change level compatible with the feature, conversion, or upgrade. Some of these transactions (called "Net-Priced" transactions) may include additional parts and associated replacement parts that are provided on an exchange basis. All removed parts become the property of IBM and must be returned to IBM.

Replacement parts assume the remaining warranty of the parts they replace.

If a Machine does not function as warranted during the warranty period, IBM or your reseller will repair or replace it (with a Machine that is at least functionally equivalent) without charge. If IBM or your reseller is unable to do so, you may return it to your place of purchase and your money will be refunded.

If you transfer a Machine to another user, warranty service is available to that user for the remainder of the warranty period. You should give your proof of purchase and this Statement to that user.

### Warranty Service

To obtain warranty service for the Machine, you should contact your reseller or call IBM. In the United States, call IBM at **1-800-772-2227**. In Canada, call IBM at **1-800-565-3344**. You may be required to present proof of purchase.

Depending on the Machine, the service may be 1) a "Repair" service at your location (called "On-site") or at one of IBM's or a reseller's service locations (called "Carry-in") or 2) an "Exchange" service, either On-site or Carry-in.

When a type of service involves the exchange of a Machine or part, the item IBM or your reseller replaces becomes its property and the replacement becomes yours. The replacement may not be new, but will be in good working order and at least functionally equivalent to the item replaced.

It is your responsibility to:

1. obtain authorization from the owner (for example, your lessor) to have IBM or your reseller service a Machine that you do not own;
2. where applicable, before service is provided —
  - a) follow the problem determination, problem analysis, and service request procedures that IBM or your reseller provide,
  - b) secure all programs, data, and funds contained in a Machine,
  - c) inform IBM or your reseller of changes in a Machine's location, and

## Product Warranties and Notices

- d) for a Machine with exchange service, remove all features, parts, options, alterations, and attachments not under warranty service. Also, the Machine must be free of any legal obligations or restrictions that prevent its exchange; and
3. be responsible for loss of, or damage to, a Machine in transit when you are responsible for the transportation charges.

### Extent of Warranty

IBM does not warrant uninterrupted or error-free operation of a Machine.

Unless IBM specifies otherwise, IBM provides non-IBM machines on an "AS IS" basis. However, non-IBM manufacturers may provide their own warranties to you.

Misuse, accident, modification, unsuitable physical or operating environment, improper maintenance by you, removal of product labels or parts identification labels, or failure caused by a product for which IBM is not responsible may void the warranties.

THESE WARRANTIES REPLACE ALL OTHER WARRANTIES, EXPRESS OR IMPLIED, INCLUDING, BUT NOT LIMITED TO, THE IMPLIED WARRANTIES OF MERCHANTABILITY AND FITNESS FOR A PARTICULAR PURPOSE. HOWEVER, SOME LAWS DO NOT ALLOW THE EXCLUSION OF IMPLIED WARRANTIES. IF THESE LAWS APPLY, THEN ALL EXPRESS AND IMPLIED WARRANTIES ARE LIMITED IN DURATION TO THE WARRANTY PERIOD. NO WARRANTIES APPLY AFTER THAT PERIOD.

In Canada, warranties include both warranties and conditions.

Some jurisdictions do not allow limitations on how long an implied warranty lasts, so the above limitation may not apply to you.

### Limitation of Liability

Circumstances may arise where, because of a default on IBM's part (including fundamental breach) or other liability (including negligence and misrepresentation), you are entitled to recover damages from IBM. In each such instance, regardless of the basis on which you are entitled to claim damages, IBM is liable only for:

1. bodily injury (including death), and damage to real property and tangible personal property; and
2. the amount of any other actual loss or damage, up to the greater of \$100,000 or the charge for the Machine that is the subject of the claim.

Under no circumstances is IBM liable for any of the following:

1. third-party claims against you for losses or damages (other than those under the first item listed above);
2. loss of, or damage to, your records or data; or
3. economic consequential damages (including lost profits or savings) or incidental damages, even if IBM is informed of their possibility.

Some jurisdictions do not allow the exclusion or limitation of incidental or consequential damages, so the above limitation or exclusion may not apply to you.

This warranty gives you specific legal rights and you may also have other rights which vary from jurisdiction to jurisdiction.

## Notices

References in this publication to IBM products, programs, or services do not imply that IBM intends to make these available in all countries in which IBM operates. Any reference to an IBM product, program, or service is not intended to state or imply that only that IBM product, program, or service may be used. Any functionally equivalent product, program, or service that does not infringe any of the intellectual property rights of IBM may be used instead of the IBM product, program, or service. The evaluation and verification of operation in conjunction with other products, except those expressly designated by IBM, are the responsibility of the user.

IBM may have patents or pending patent applications covering subject matter in this document. The furnishing of this document does not give you any license to these patents. You can send license inquiries, in writing, to the IBM Director of Licensing, IBM Corporation, 500 Columbus Avenue, Thornwood, NY 10594, U.S.A.

## Trademarks

The following terms, in this publication, are trademarks of the IBM Corporation in the United States or other countries or both:

IBM	PS/2
Operating System/2	RediSafe
OS/2	ThinkPad
PC Card Director	TrackPoint III
	WIN-OS/2

Microsoft, Windows, Windows NT, and the Windows 95 flag logo are trademarks or registered trademarks of Microsoft Corporation.

Intel , Pentium , and MMX are trademarks or registered trademarks of Intel Corporation in the U.S. and other countries.

Other company, product, and service names, which may be denoted by a double asterisk (\*\*), may be trademarks or service marks of others.

## Electronic Emission Notice

# Electronic Emission Notice

### *Federal Communications Commission (FCC) Statement*

ThinkPad 380XD or 385XD, 2635

This equipment has been tested and found to comply with the limits for a Class B digital device, pursuant to Part 15 of the FCC Rules. These limits are designed to provide reasonable protection against harmful interference in a residential installation. This equipment generates, uses, and can radiate radio frequency energy and, if not installed and used in accordance with the instructions, may cause harmful interference to radio communications. However, there is no guarantee that interference will not occur in a particular installation. If this equipment does cause harmful interference to radio or television reception, which can be determined by turning the equipment off and on, the user is encouraged to try to correct the interference by one or more of the following measures:

- Reorient or relocate the receiving antenna.

- Increase the separation between the equipment and receiver.

- Connect the equipment into an outlet on a circuit different from that to which the receiver is connected.

- Consult an IBM authorized dealer or service representative for help.

Properly shielded and grounded cables and connectors must be used in order to meet FCC emission limits. Proper cables and connectors are available from IBM authorized dealers. IBM is not responsible for any radio or television interference caused by unauthorized changes or modifications to this equipment. Unauthorized changes or modifications could void the user's authority to operate the equipment.

This device complies with Part 15 of the FCC Rules. Operation is subject to the following two conditions: (1) this device may not cause harmful interference, and (2) this device must accept any interference received, including interference that may cause undesired operation.

Responsible Party:

International Business Machines Corporation  
Old Orchard Road  
Armonk, NY 10504  
Telephone 1-919-543-2193



## Electronic Emission Notice

### *Canadian Department of Communications Compliance Statement*

This equipment does not exceed Class B limits per radio noise emissions for digital apparatus, set out in the Radio Interference Regulation of the Canadian Department of Communications.

### *Avis de conformité aux normes du ministère des Communications du Canada*

Cet équipement ne dépasse pas les limites de Classe B d'émission de bruits radioélectriques pour les appareils numériques, telles que prescrites par le Règlement sur le brouillage radioélectrique établi par le ministère des Communications du Canada.

### *European Community Directive Conformance Statement*

This product is in conformity with the protection requirements of EC Council Directive 89/336/EEC on the approximation of the laws of the Member States relating to electro-magnetic compatibility.

A declaration of Conformity with the requirements of the Directive has been signed by IBM United Kingdom Limited, PO BOX 30 Spango Valley Greenock Scotland PA160AH.

This product satisfies the Class B limits of EN 55022.

**Electronic Emission Notice**

## Glossary

---

This glossary includes terms and definitions from the *IBM Dictionary of Computing* (New York: McGraw-Hill, 1994).

**AC.** Alternating current.

**AC power.** Power that is supplied to the computer through an electrical outlet.

**Advanced Power Management (APM).** A facility consisting of one or more layers of software that support power management in computers with power manageable hardware. The APM software interface allows applications, operating systems, device drivers, and the APM BIOS to work together to reduce power consumption, without reducing system performance.

**ANSI.** American National Standards Institute.

**APM.** Advanced Power Management

**application program.** A program that performs specific tasks on your computer, such as word processing or creating spreadsheets.

**ASCII.** American National Standard Code for Information Interchange.

**ATA PC Card.** A PC Card with an AT attachment hard disk drive interface such as a storage device PC Card.

**AUTOEXEC.BAT.** A file that contains a startup procedure of DOS. Each time you start your system, DOS performs the commands that are stored in this file.

**backup copy.** A copy, usually of a file or group of files, that is kept in case the original file or files are unintentionally changed or destroyed.

**batch.** A process method in which a program or programs records with little or no operator action.

**BIOS (Basic Input/Output System).**

Microcode that contains such basic hardware operations as interactions with diskette drives, hard disk drives, and the keyboard.

**bitmap graphics.** (1) A form of graphics in which all points on the display are directly addressable. (2) In multimedia applications, a form of graphics in an area of computer memory or storage that can be displayed as an image.

**boot.** To prepare a computer system for operation by loading an operating system.

**bps.** Bits per second. In serial transmission, the instantaneous bit speed with which a device or channel transmits a character.

**bus.** A facility for transferring data between several devices located between two end points, only one device being able to transmit at a given moment.

**cache memory.** A special memory, smaller and faster than main memory, that is used to hold a copy of instructions and data in main memory that are likely to be needed next by the processor, and that have been obtained automatically from main memory.

**CD-i.** Compact disc-interactive.

**CD-ROM.** High-capacity read-only memory in the form of an optically read compact disc.

**combination keys.** Keys that have specific functions when you hold them down at the same time.

**CONFIG.SYS.** A file that contains a group of commands to load installable device drivers and reserve space in system memory for information

## Glossary

processing. This file is referred to by DOS during system startup.

**configuration.** (1) The manner in which the hardware and software of an information processing system are organized and interconnected. (2) The physical and logical arrangement of devices and programs that make up a data processing system. (3) The devices and programs that make up a system, subsystem, or network.

**CRT.** Cathode ray tube display.

**device driver.** (1) A file that contains the code needed to use an attached device. (2) A program that enables a computer to communicate with a specific peripheral device—for example, a printer, a video disc player, or a CD drive. (3) A collection of subroutines that control the interface between I/O device adapters and processors.

**DIMM.** Dual inline memory module.

**directory.** A type of file containing the names and controlling information for other files or other directories.

**DMA.** Direct memory access. The transfer of data between memory and input/output units without processor intervention.

**double-click.** To press and release a mouse button twice within a time frame defined by the user, without moving the pointer off the choice.

**ECP.** Extended Capability Port.

**EGA.** Enhanced graphics adapter.

**EIA.** Electronics Industries Association.

**EIA-232D.** An EIA interface standard that defines the physical, electronic, and functional characteristics of an interface line that connects a communication

device and associated workstation. It uses a 25-pin connector and an unbalanced line voltage.

**EMS.** Expanded memory specification.

**FAQ.** Frequently asked questions.

**fax.** (1) Facsimile machine. (2) A transmitted document from a facsimile machine.

**fixed disk.** In personal computing, *fixed disk* is synonymous with *hard disk*.

**Flash memory.** Electrically rewritable storage.

**folder.** A file used to store and organize documents.

**fuel gauge.** An indicator on the screen that constantly shows the current power status of the battery pack.

**gigabyte (GB).** 1 billion bytes.

**hard disk drive (HDD).** A stand alone disk drive that reads and writes data on rigid disks and can be attached to a port on the system unit.

**HHR.** Half-horizontal resolution.

**hibernation.** One of the power-saving methods that stores data and applications running in the computer's memory on the hard disk. During hibernation, the computer is automatically turned off to save power. When power is turned on again, the computer immediately restores the same data and applications as when hibernation started, without restarting the operating system.

**high-resolution mode.** Video resolutions that are greater than 640 by 480 pels.

**icon.** A graphic symbol, displayed on a screen, that a user can point to with a

## Glossary

pointing device such as a TrackPoint III or mouse to select a particular function or software application.

**IDE.** Integrated device electronics.

**IR.** Infrared.

**ISA.** Industry standard architecture.

**ISO.** International Organization for Standardization.

**JEIDA.** Japan Electronics Industry Development Association.

**kilobyte (KB).** 1024 bytes.

**LAN.** Local area network.

**MCI.** Media Control Interface.

**megabyte (MB).** 1024 kilobytes. About 1 million bytes.

**memory.** Often referred to as random-access memory (RAM), measured in kilobytes (KB) or megabytes (MB) of information.

**MHz.** Megahertz.

**microcode.** One or more microinstructions used in a product as an alternative to hard-wired circuitry to implement functions of a processor or other system component.

**MIDI.** Musical Instrument Digital Interface.

**modem.** A device that connects your computer to a telephone line, allowing it to communicate with another computer at another location.

**parallel port.** A port used to attach such devices as dot-matrix printers and input/output units; it transmits data 1 byte at a time.

**partial suspend mode.** A kind of suspend mode where only a part of the system components uses power.

**password.** A series of letters or numbers that you designate to restrict access to your computer.

**PC Card.** A card that is based on the PC Card standard.

**PCMCIA.** Personal Computer Memory Card International Association.

**pel.** Picture element.

**picture element.** In computer graphics, the smallest element of a display surface that can be independently assigned color and intensity.

**pixel.** Picture element.

**pointing device.** An instrument, such as a mouse, TrackPoint III, or joystick, that is used to move a pointer on the screen.

**pop-up menu.** On the display screen, a menu that emerges in an upward direction from a particular point or line on a display screen.

**POST.** Power-on self-test.

**prompt.** A visual or audible message sent by a program to request the user's response.

**pull-down menu.** On the display screen, a menu that emerges in a downward direction from a point or line at or near the top of the screen.

**reboot.** To restart all operations of the computer as if the power had just been turned on.

**resume.** To begin computer operations again from suspend mode.

## Glossary

**ROM.** Read-only memory.

**serial port.** A port used to attach such devices as display devices, letter-quality printers, modems, plotters, and such pointing devices as light pens and mice; it transmits data 1 bit at a time.

**suspend.** To stop all operations of the computer to reduce power drain and restrict access to the files.

**SVGA.** Super video graphics adapter.

**TFT.** Thin-film transistor.

**TSRs.** Terminate-and-stay-resident programs, memory-resident programs that are loaded into memory and stay

there so you can conveniently access them whenever you need to.

**vertical expansion.** A video display technique in character-display mode to fit video images on the whole LCD screen by adjusting the number of character dots vertically.

**VESA.** Video Electronics Standards Association.

**VGA.** Video graphics adapter, a video mode that produces up to 640-by-480 resolution.

**VSYNC.** Vertical synchronization frequency.

**XMS.** Extended memory specification.

## A

America Online 176  
APM (advanced power management) 106  
audio features, using 73

## B

battery pack  
  charging 88  
  fuel-gauge program, using 92  
  low-battery condition 90  
  monitoring battery power  
    battery status indicator, using 88  
    fuel-gauge program, using 92  
  problems 148  
  replacing 109  
  status indicator 9, 89  
battery save method 93, 108  
brightness control 5  
bulletin boards 175

## C

caps lock indicator 9  
CardWorks 66  
CD-ROM drive  
  problems 149  
charging, battery pack 88  
click buttons (TrackPoint III) 10  
CompuServe 176  
corrective service diskette (CSD) 180

## D

dealer locations 174  
diagnostic diskette 180  
DIMM, installing 40  
diskette standards 182  
display  
  problems 147  
  switching, using Fn key 13  
drive  
  in use, indicator 9

## E

Easy-Setup  
  changing drive startup sequence 28  
  knowing your configuration 26  
  setting date and time 27  
  using 25  
EasyServ 174  
electronic support 175  
enhanced PC support line 177  
ergonomics information 34  
error codes 138  
external display  
  problems 155  
external keyboard  
  attaching 50  
external monitor  
  attaching 52  
  display driver  
    setting 53  
  problems 52  
  SVGA modes, using 56  
  using 52  
external numeric keypad  
  attaching 49  
  problems 143  
external-input-device connector 5

## F

features 182  
fee, services 176  
Fn key  
  function 12  
  location 5  
  lock 12  
fuel-gauge program  
  Fn key function, using 13  
  monitoring battery status 92  
  using 92  
function keys  
  Fn + F12 94  
  Fn + F3 93  
  Fn + F4 93

## Index

### H

- hard disk password 112
- hardware specifications 182
- heat output, machine specifications 182
- help
  - CardWorks 72
- hibernation
  - considerations 104
  - using
    - Fn key function 13
- hibernation mode
  - enabling 101
  - problems 144
- humidity, machine specifications 182

### I

- I99xxxx
  - See error codes
- identification numbers, recording 171
- indicator panel 8
- infrared communication 77
- infrared port
  - location 5
  - problems 150
- input voltage 183
- installing
  - DIMM 40
  - external keyboard 50
  - external numeric keypad 49
  - mouse 49
  - PC Card 58

### K

- keyboard
  - external, attaching 50
  - location 5
  - problems 143
  - specifications 182
- keyboard/mouse connector 50

### L

- LCD
  - location 5
  - problems 56, 147
  - using 52
- locations 2—7
- lock, mechanical 127
  - using 127
- low-battery condition 90

### M

- memory
  - increasing capacity 40
  - slot
    - cover 7
    - location 7
    - specifications 182
- memory module (DIMM) 40
- messages on screen 138
- microprocessor, specifications 182
- monitor
  - See also external monitor
  - output type 52
  - problems 52
  - using 52
- mouse
  - attaching 49
  - space saver keyboard 51
  - using with
    - TrackPoint III 49

### N

- Network and Server Support fee 178
- notices and warranties, product 187
- numeric keypad 15
- numeric lock indicator 9

### O

- operating system
  - updates 180
- options



## Index

- options (*continued*)
  - DIMM 40
  - external keyboard 50
  - external monitor 52
  - external numeric keypad 49
  - mouse 49
  - PC Card
    - installing 58
  - problems 159
- P**
- part numbers, power cords 184
- password 112
  - entering 112
  - hard disk password 112
  - power-on password 112
  - setting 113
  - supervisor password 112
- PC Card
  - eject button 5
  - installing 58
  - keyhole 5
  - problems 151
  - removing 65
  - slot 5
  - suspend mode, using with 103
- PC Card information
  - CardWorks 68
- PC Card support software
  - CardSoft mode 67
  - for Windows 95, CardWorks 66
  - Plug and Play mode 66
- personalization editor 123
- pointing device
  - attaching 49
  - problems 143
- port replicator
  - attaching 80
  - detaching 84
  - problems 157
  - using 80
- POST error prompt 138
- power command 106
- power cords 184
- power management
  - hibernation mode 94
  - standby mode 93
  - suspend mode 93
- power mode
  - switching, using Fn key 13
- power-on indicator 9
- power-on password 112
- printer
  - problems 155
- problems
  - battery pack 148
  - CD-ROM drive 149
  - error codes 138
  - external display 155
  - external numeric keypad 143
  - hibernation mode 144
  - infrared 150
  - keyboard 143
  - LCD 56, 147
  - messages on screen 138
  - monitor 52
  - options 159
  - PC Card 151
  - pointing device 143
  - port replicator 157
  - printer 155
  - serial port 159
  - software 161
  - suspend mode 144
  - testing the computer 163
  - TrackPoint III 143
  - troubleshooting charts 130, 162
- Prodigy 176
- publications
  - ordering 180
- R**
- repair services 180
  - getting service 180
  - identification numbers 171

## Index

### S

- safety notice viii
- sales information 174
- screen expansion 56
- scroll lock indicator 9
- security
  - mechanical lock 127
- security features
  - password 112
  - personalization editor 123
- self-check
  - CardWorks 68
- send a file 79
- serial number 171
- serial port
  - problems 159
- service 180
  - how to get 180
- ServicePak 180
- size, machine specifications 182
- software
  - problems 161
- space saver keyboard 51
- specifications 182
  - battery pack 183
  - heat output 182
  - humidity, environment 182
  - input voltage 183
  - power cords 184
  - size 182
  - temperature, environment 182
  - weight 182
- SRS function, using 74
- standards, diskette 182
- standby mode
  - Fn key function, using 13
  - timer 99
- Stopping a PC Card
  - CardWorks 72
- supervisor password 112
- suspend mode
  - considerations 102
  - Fn key function, using 13
  - problems 144
- suspend mode (*continued*)
  - timer 99
- suspend-mode indicator 9
- SVGA monitor 52
- system-status indicators
  - battery lamp 9
  - caps lock 9
  - drive in use 9
  - location 8
  - numeric lock 9
  - power on 9
  - scroll lock 9
  - suspend mode indicator 9

### T

- technical support 173
  - fee 176
- telephone assistance 173
- temperature, machine
  - specifications 182
- testing the computer 163
- ThinkPad Configuration for DOS 23
- ThinkPad Configuration for OS/2 21
- ThinkPad Configuration for Windows
  - 3.11 21
- ThinkPad Configuration for Windows
  - 95 19
- ThinkPad Configuration for Windows
  - NT 21
- ThinkPad EasyServ 179
- TrackPoint III
  - changing the cap 12
  - location 5
  - problems 143
  - using 10
- TranXit 77
- troubleshooting
  - charts 130
  - USB port 151

### U

- updating, operating system 180

**V**

volume control  
location 5

**W**

warranty  
    extensions and upgrades 179  
    product 187  
    service, international 174  
weight, machine specifications 182  
Wizard button  
    for CardWorks 68

IBM

Part Number: 05L2143

Printed in the United States of America

5L2143

